

Oldřich Polách *

O KONŠTRUKCII POJAZDOV S RADIÁLNE NATÁČANÝMI DVOJKOLESIAMI

ON THE DESIGN OF RUNNING GEARS WITH RADIAL STEERING WHEEL SETS

Zníženie hlučnosti koľajových vozidiel môže byť dosiahnuté vhodnou konštrukciou ich podvozkov a pojazdov. Dvojkolesia natáčané do radiálnej polohy zamedzujú pískanie v oblúkoch koľaje. Okrem toho znižujú priečne sily medzi kolesom a koľajnicou aj ich opotrebenie. Konštrukčné zásady pre vývoj vzájomne viazaných, samočinne sa natáčajúcich dvojkolesí sú uvedené na príkladoch podvozkov pre nové článkové vozidlá TEŽ a spojené jednonápravové pojazdy FEBA pre predmestské súpravy NSB Class 72 firmy Bombardier Transportation Winterthur.

Noise reduction of railway vehicles can be reached by suitable design of their bogies and running gears. Radial steering wheel sets avoid curve squeal. Besides they reduce lateral forces between the wheel and rail and their wear. Design principles for the development of inter-connected self-steering wheel sets are introduced on examples of bogies for new articulated vehicles TEŽ and coupled single-axle running gears FEBA for commuter trains NSB Class 72 from Bombardier Transportation Winterthur.

1. Environmental design of bogies and running gears for railway vehicles

The influence of railway vehicles on the environment has to be considered in their design. Noise reduction is an important issue, which can be influenced by the design of bogies and running gears [1]. More than the rolling noise and impact noise on crossings, high level curve squeal in tight curves with a small curve radius annoys people who live in the vicinity of a railway line. Curve squeal is the intense tonal noise caused by wheel vibration when entering the curve [2]. The modelling and calculation of curve squeal noise generation is referenced in [3]. The excitation mechanism essentially generates lateral forces due to frictional instability. It is connected with lateral stick-slip motion between wheel and rail when running through a curve. The lateral creep (slip) s_y is proportional to the angle of attack (Fig. 1)

$$s_y = \frac{u_y}{v} = \frac{v \cdot \tan \alpha}{v} = \tan \alpha \cong \alpha \quad (1)$$

with u_y lateral creep (slip) velocity
 v vehicle speed
 α angle of attack.

Reducing the angle of attack, lateral slip is reduced and the curve squeal can be avoided or at least reduced. Even when a conventional bogie does not squeal in a curve, the wheel-rail noise of a radial steering wheel set is lower than of a conventional one. The measured difference in a curve with 400 m radius reaches 3–4 dB(A) [1]. Wheel sets steered in curve into the radial position not only prevent curve squeal, they also lower track fatigue reducing the

lateral wheel-rail forces and reduce the wear of wheels and rails, which is proportional to the friction work A_R related to one meter of rail length

$$A_R = |X \cdot s_x| + |Y \cdot s_y| + |\Theta \cdot \omega| \quad (2)$$

with X longitudinal force between the wheel and rail
 Y lateral force between the wheel and rail
 $s_x, (s_y)$ longitudinal (lateral) creep in the wheel-rail contact
 Θ moment around the normal axis to the contact plane
 ω spin creep in wheel-rail contact (rotation around the normal axis to the contact plane).

To achieve radial adjustment of wheel sets, passive or active systems can be used. Less expensive passive systems can be divided into

- self-steering wheel sets with soft guidance
- inter-connected wheel sets
- force-steering wheel sets.

The self-steering wheel sets are characterised by soft wheel set guidance between the axle and bogie frame. The steering effect is based on the longitudinal creep forces between the wheel and rail due to differences in the rolling path and rolling radius of the left and right wheel. The steering effect is sensitive to the conditions in the wheel-rail contact. Because of conflicting demands of self-steering and stability, the steering effect of wheel sets with soft guidance as well as maximum speed of vehicle are limited.

Inter-connected wheel sets use the same effect, but increased by the forces and moments in their coupling. They can achieve

* Doc. Ing. Oldřich Polách, PhD.

Bombardier Transportation Ltd, Zürcherstraße 41, CH-8401 Winterthur, Switzerland, oldrich.polach@ch.transport.bombardier.com

higher speed and better steering ability compared with soft guided wheel sets without coupling.

The steering mechanism of force-steering wheel sets uses the movement between the bogie frame and carbody or between two carbodies to adjust the wheel sets. The system is sensitive to the exact geometry of steering mechanism.

Bogies and running gears with radial steering wheel sets reduce maintenance costs caused by wear and track fatigue and meet recommendations for an environmental friendly design. Design principles and construction of self steering inter-connected wheel sets will be introduced on examples of bogies for articulated vehicles GTW and coupled single-axle running gears FEBA of Norwegian commuter trains Class 72 from Bombardier Transportation Winterthur.

2. Bogies with coupled wheel sets

The longitudinal axle guidance of self-steering wheel sets has to be very soft to allow radial adjustment by creep forces in the wheel-rail contact. In spite of this, the transmission of traction and braking forces should not lead to large longitudinal wheel set movement. Besides, a conventional bogie design with soft axle guidance reduces the stability limit significantly.

These contradictions can be solved by the coupling of wheel sets as shown symbolically in Fig. 2. The bending stiffness k_{B2} acts in parallel to the equivalent bending (steering) stiffness k_{B1} of the axle guidance and primary suspension

$$k_{B1} = w_p^2 \cdot k_{P_x} \quad (3)$$

with k_{P_x} - longitudinal stiffness of axle guidance and primary suspension (per wheel)

w_p - half distance of axle guidance in lateral direction.

The lateral coupling stiffness k_{S2} acts in parallel to the equivalent shear stiffness k_{S1} of the axle guidance and primary suspension

$$k_{S1} = \frac{k_{B1} \cdot k_{P_y}}{k_{B1} + b^2 \cdot k_{P_y}} \quad (4)$$

with k_{P_y} - lateral stiffness of axle guidance and primary suspension (per wheel)

b - half wheel set base in longitudinal direction.

To achieve good self steering ability together with high stability, the bending stiffness k_{B2} must be very low or zero, but the lateral (shear) coupling must be very stiff. In addition, the transmission of traction and braking forces should be separated and should not influence the steering of the wheel sets.

There are various examples of bogies with self steering wheel sets which are coupled with each other. A steering mechanism with transverse shaft transmitting the longitudinal forces between the wheel sets and bogie frame [4], [5] is implemented in loco-

motives Re 460 of the Swiss Federal Railways (SBB) for maximum speed of 230 km/h. An application of a similar mechanism in newly developed modular locomotive bogies is described in [6].

In Slovakia, coupled self-steering wheel sets are used in the new vehicles series 425.95 (Fig. 3) on TEŽ metre-gauge line in the High Tatras. The articulated vehicles are produced by ŽOS Vrútky in co-operation with the Swiss manufacturer Stadler and Bombardier Transportation works in Switzerland. The bogies are delivered by Bombardier Transportation Winterthur. This type of vehicle called GTW was first produced by Stadler in 1995. The GTW vehicles with the bogies from Bombardier Transportation [7], [8], [9] are now in service in Germany, USA, Switzerland and Slovakia on standard and narrow gauge lines.

The trailer bogies (Fig 4a) are particularly suited to extreme track distortion because their torsionally elastic bogie frame means lower wheel unloading. The braking forces are transmitted by a traction rod which connects the wheel set directly with carbody without acting on the primary suspension. Two secondary air springs and lateral and longitudinal dampers ensure a quiet ride comfort. The lateral coupling of wheel sets by axle-hung supports results in their good radial alignment with less wear of wheel as well as smooth negotiation of narrow curves without squeal. The traction running gear (Fig. 4b) is especially designed to fit short traction modules of articulated vehicles like the GTW. The innovative lightweight construction allows eliminating bogie frame. The body of traction unit is suspended by helical springs directly on the axle boxes. Two axle-hung motor gear units, suspended from the carbody, are connected by lateral coupling. In this way the lateral coupling of wheel sets is realised and its self-steering ability improved similar as on the trailer bogie. A traction rod between the motor gear unit and the body of the traction unit transfers the tractive and braking forces.

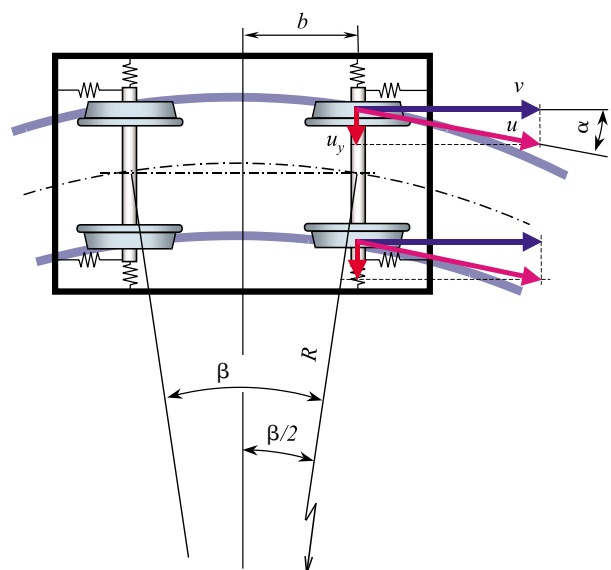

Fig. 1 Bogie with stiff axle guidance in a curve

Radial adjustment of GTW wheel sets in curves was proven by measurement of steering angle β between the wheel sets of the trailer bogie. The ideal steering angle can easily be calculated from the curve radius and bogie geometry (assuming a tangential bogie position, Fig. 1) as

$$\beta = 2 \cdot \alpha = \frac{2 \cdot b}{R}$$

with R - curve radius.

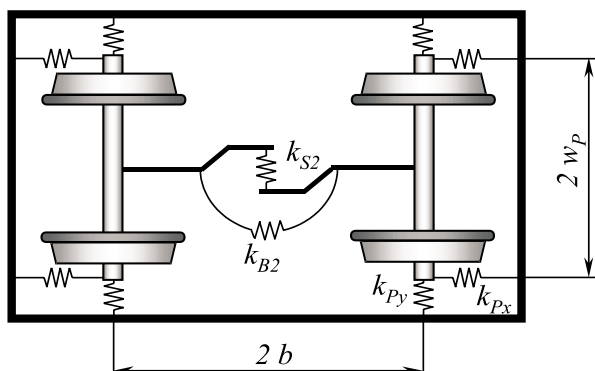

Fig. 2 Bogie with inter-connected wheelsets

angle comes to the ideal steering angle, the better the wheel sets align themselves. The measurements statistically confirm a good radial alignment of the wheel sets. The slope of the regression line of all measured points for the curve range between the radius of 100 m and infinite (straight line) reaches 70% of the ideal value compared with rigid axle guidance bogies.

3. Coupled single-axle running gears

The coupled single-axle running gears called FEBA have been developed by Bombardier Winterthur as a modern solution for regional service. They were chosen by the Norwegian State Railways for the new electrical units Class 72 (Fig. 6). The four-part commuter train with a top speed of 160 km/h was built by a consortium of ANSALDOBREDA (Italy) and Bombardier Transportation Winterthur. The coupled single-axle running gears FEBA are used similarly to Jakob-bogies of articulated vehicles. Two each running gears are coupled beneath the coach ends of the centre coach. On the ends of the composition, motor bogies enabling steering of the wheel sets by way of soft wheel set guidance are used.

The coupled single-axle running gears ideally unite the characteristics of bogie and single-axle. They can be utilised independent of the type of carbody coupling. In difference to Jakob-bogies, easy

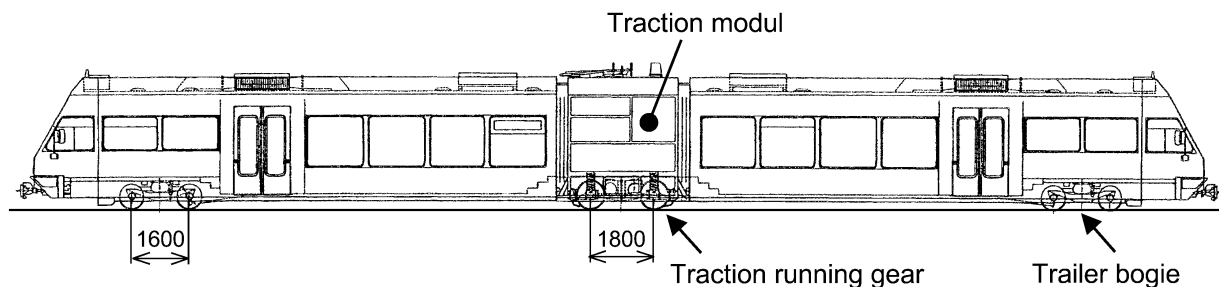

Fig. 3 Vehicle GTW (from German "Gelenktriebwagen") TEŽ series 425.95 (drawing Stadler)

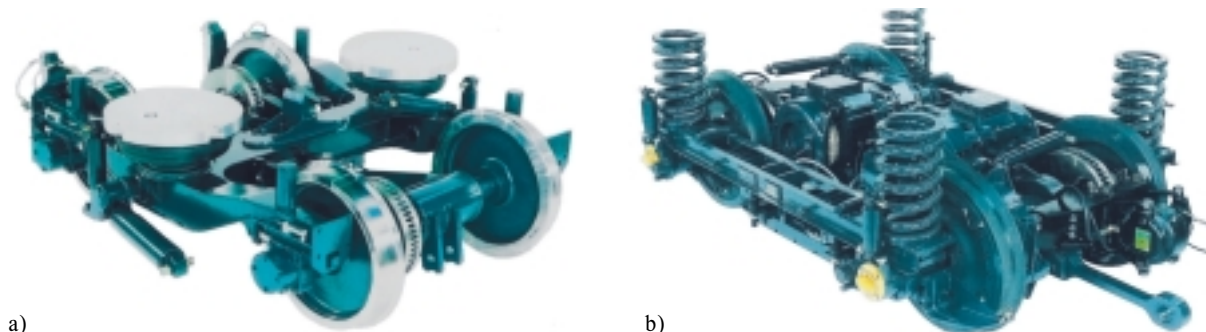

Fig. 4 Bogies of GTW-vehicles: trailer bogie (a) and traction running gear (b)

Values of steering angle measured on GTW-vehicles of metre-gauge Swiss private railways BTI [8] are shown in Fig. 5. The measured vehicles have the same design and similar running conditions as the vehicles TEŽ 425.95. The closer the measured steering

and fast uncoupling of the individual cars for maintenance purposes is still guaranteed without the necessity of auxiliary bogies.

The design of the running gears is based on components already extensively tried and utilised in railway vehicles (Fig. 7). The

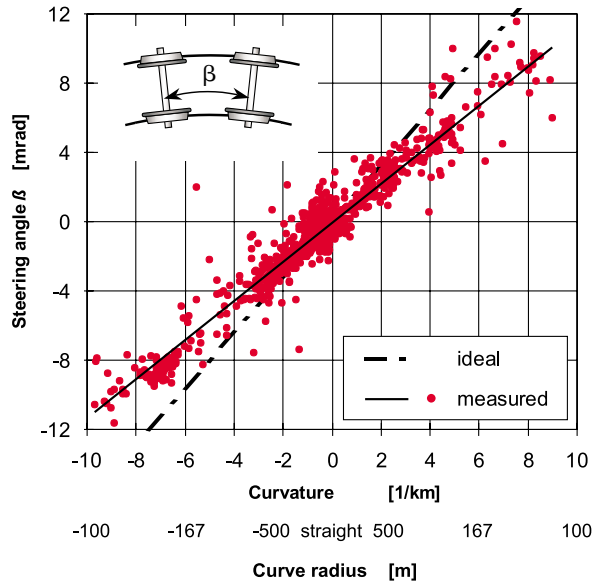

Fig. 5 Measured steering angles between the wheelsets of the metre-gauge GTW trailer bogie on BTI-line in Switzerland

carbody, and also support it against pitching. The vertical, lateral and longitudinal dampers ensure quiet running behaviour.

The technical principle of the coupling of single-axle running gears is shown in Fig. 8. The running gears are coupled by way of two horizontal parallel-aligned traverse rods, so that the single running gears can move towards each other in a longitudinal and vertical direction. The yaw stiffness $k_{\varphi z}$ of the running gears coupling around the vertical axis is determined by the radial stiffness of the spherical rubber elements k_{rad} and by the longitudinal distance l of the coupling rods

$$k_{\varphi z} = \frac{l^2}{4} \cdot k_{rad} \quad (5)$$

The lateral stiffness k_y of the running gears coupling is

$$k_y = k_{rad} \quad (6)$$

Apart from the important parameters given in the equations (5) and (6), the torsional stiffness of the spherical rubber element and the flexibility of the frames of both running gears should be taken into account in the exact layout of the yaw stiffness and the lateral stiffness of the running gears coupling.

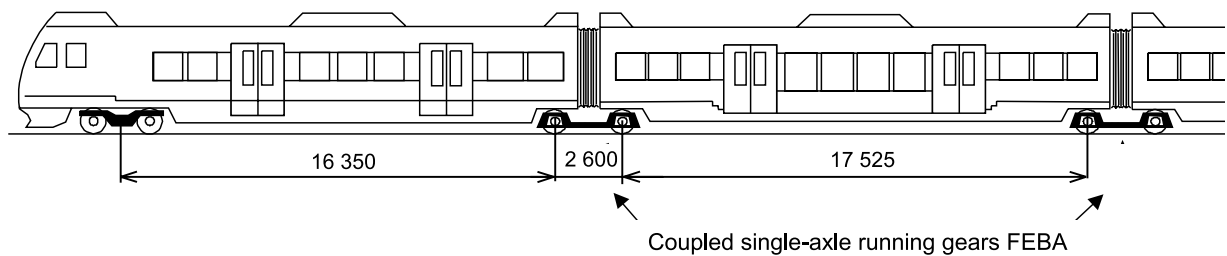

Fig. 6 A half of the four-part commuter train Class 72 of Norwegian Railways

primary suspension is constituted by rubber Chevron springs. Air springs with an auxiliary air volume serve as the secondary suspension. The braking force transmission is realised by two traction rods (Fig. 9), which couple each running gear longitudinally on its



Fig. 7 The serial single-axle running gear of NSB commuter train Class 72

The coupling of the running gears enables optimum running behaviour during curving and increases the running stability [10]. In comparison with a Jakob-bogie, both running gears demonstrate a high torsional flexibility towards each other, providing better safety against derailment on bad track quality.

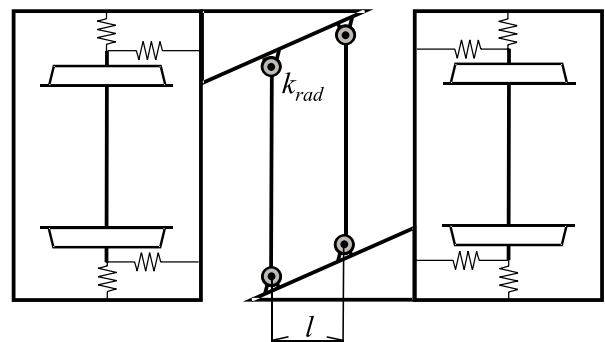

Fig. 8 Principle of the single-axle running gears coupling using two parallel lateral rods

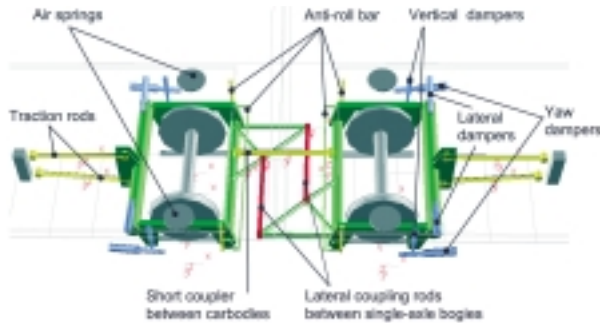

Fig. 9 Simulation model of coupled single-axle running gears FEBA in SIMPACK

Through the coupling of the single-axle running gears, a combination of force-steering and inter-connected steering of the wheel sets is achieved. Due to yawing of the running gear versus the carbody during curving the longitudinal stiffness of the secondary suspension acts in one direction, the yaw stiffness of the coupling $k_{\varphi z}$ in the opposite direction. The single-axle running gear balances itself out in a position which lies between the stiff steered wheel set of a two-axle-vehicle and the wheel set of a Jakob-bogie with rigid axle guidance. If a sufficiently soft yaw stiffness of the running gear coupling is chosen, the wheel sets possess additional freedom to steer themselves even better in the radial position through the effect of the longitudinal creep forces between wheel and rail. Fig. 10 illustrates the forces and moments acting on the single-axle running gear. The longitudinal stiffness of the primary suspension is assumed as being very high (approx. rigid). Let us assume that the wheel set is in a radial position and no creep forces are influencing the wheels in a longitudinal direction. Without the effect of the forces between wheel and rail, the wheel set would remain

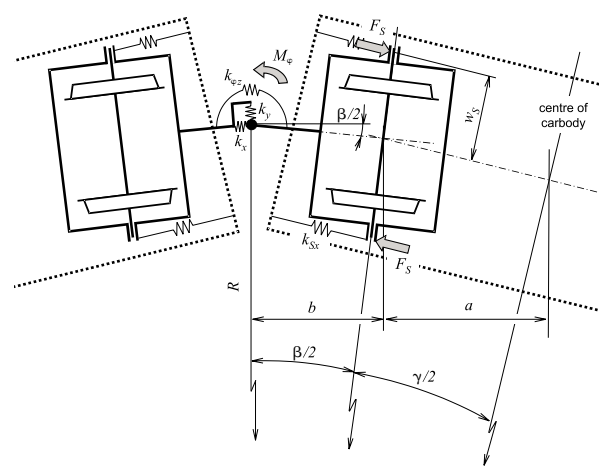

Fig. 10 Forces and moments acting on the coupled single-axle running gears during curving

in the radial position if the effective moments in the secondary suspension and in the coupling M_{φ} are balanced out

$$M_{\varphi} = 2 \cdot F_S \cdot w_S \quad (7)$$

with F_S - longitudinal force in secondary suspension
 w_S - half lateral distance of secondary suspension.

If the secondary suspension is of symmetrical design, the longitudinal stiffness resembles the lateral stiffness, whereby the lateral stiffness is determined as a result of running comfort optimisation. For the given longitudinal and lateral stiffness, we can determine from equation (7) the optimum yaw stiffness of the running gear coupling from the curving point of view

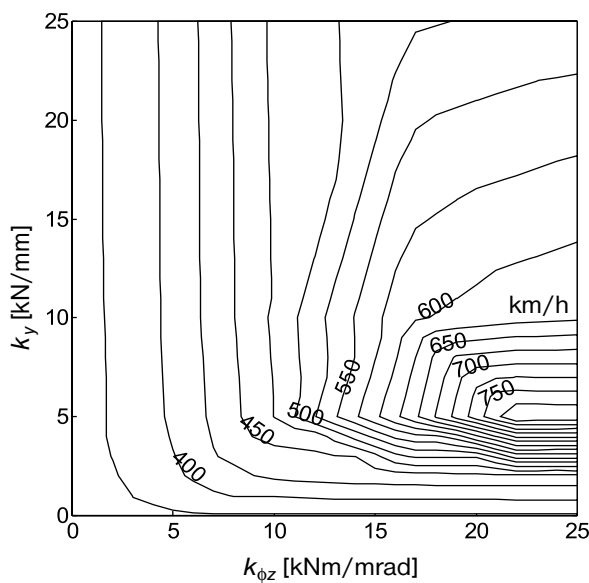

a)

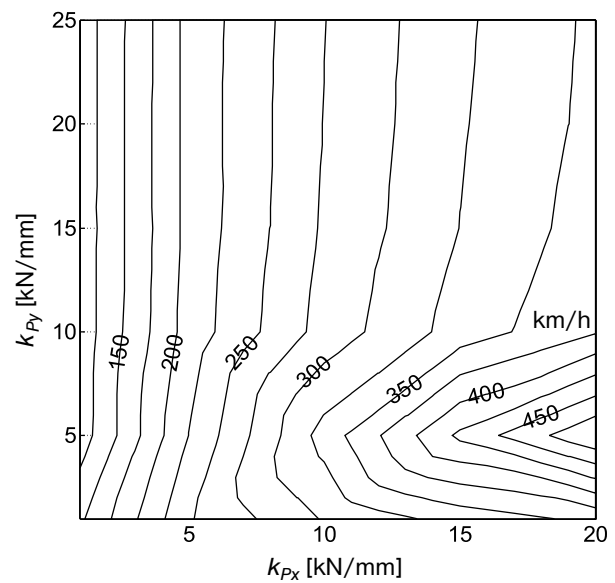

b)

Fig. 11 Influence of the coupling of single-axle running gears (a) and their primary axle guidance stiffness (b) on the critical speed

$$k_{\varphi z Opt} = \frac{a}{2 \cdot b} \cdot w_S^2 \cdot k_{Sx} \quad (8)$$

with k_{Sx} - longitudinal stiffness of secondary suspension.

If the equation (8) is fulfilled, the single-axle running gears will be radially steered during curving by the forces in the secondary suspension and in the wheel set coupling.

The coupling of the single-axle running gears increases the running stability too. The influence of primary suspension and of running gears coupling was investigated by parameter analysis on a half train simulation model (Fig. 9). The analysis results are represented with stability contour plots for a residual damping $D = 0\%$ at a conicity of 0.4 (upper conicity limit for the testing and acceptance of the vehicle according to UIC-518 for a maximum speed between 140 and 200 km/h), see Fig. 11. The stability increases with the gaining of yaw stiffness $k_{\varphi z}$ and the lateral stiffness k_y of the running gear coupling. In order to achieve a radially steering design, the yaw stiffness $k_{\varphi z}$ should be in the vicinity of the value according equation (8), therefore relatively low. Under this condition the stability can only be increased changing the lateral coupling stiffness k_y . In the primary suspension, a more important role is played by the longitudinal stiffness k_{Px} of the axle guidance. The lateral stiffness k_{Py} has a subordinate role.

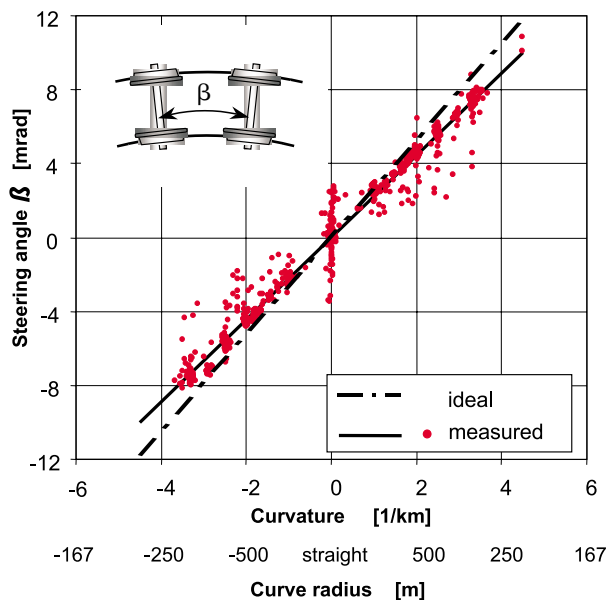

Fig. 12 Measured values of steering angle between the wheelsets of coupled single-axle running gears in comparison with calculated ideal value

The theoretical analyses carried out determine the design philosophy of the coupled single-axle running gears. The stiffness of the secondary suspension $k_{Sx} = k_{Sy}$, defined by running comfort properties, can be used for calculating the yaw stiffness $k_{\varphi z}$ of the

running gears coupling required in respect to curving according equation (8). Looking on the coupling of running gears, an increase of the critical speed can be achieved by increasing the lateral stiffness of the coupling k_y . An increase of the yaw stiffness $k_{\varphi z}$ would improve stability as well, but the value of $k_{\varphi z}$ is limited by the curving properties as already mentioned. The longitudinal axle guidance and primary stiffness k_{Px} , should be stiff. The lateral axle guidance and primary stiffness k_{Py} can be relatively soft to reduce the lateral dynamic forces between wheel and rail.

Prior to series application of the coupled single-axle running gears FEBA, two prototype running gears were subjected to extensive tests [11], [12]. The test runs have completely confirmed the anticipated running characteristics. The capability of the running gears to steer themselves radially in a curve was judged by measuring the steering angle (Fig. 12) between the wheel sets of the coupled running gears. The measurements confirmed almost ideal radial steering ability in curves with radii between 300 m and 500 m. The slope of the regression line reaches 84% of the ideal value. Subsequently, the wheel-rail forces are low as described in [12]. The vehicle type tests in autumn 2000 and summer 2001 demonstrated the fulfilment of the anticipated design results and the compliance with the limit values.

4. Conclusion

Bogies and running gears with radial steering wheel sets reduce maintenance costs caused by wear and track fatigue and meet recommendations for environment friendly design. To achieve steering ability of a two-axle bogie, the longitudinal guidance between the axle and bogie frame have to be soft. A lateral coupling between the wheel sets increases the stability and improves the curving properties of soft guided wheel sets. Traction and braking forces between the axle and bogie frame have to by-pass the axle guidance to avoid a negative influence on the self-steering effect. The principles mentioned were used by Bombardier Transportation Winterthur when developing the bogies for articulated GTW-vehicles. In Slovakia, these bogies are used in the new vehicles TEŽ series 425.95.

The coupled single-axle running gears FEBA developed by Bombardier Transportation Winterthur for the four-part commuter trains Class 72 of the Norwegian State Railways ideally unite the characteristics of bogie and single-axle. Through the coupling of the single-axle running gears, a combination of force-steering and inter-connected steering of the wheel sets is achieved with almost ideal radial steering ability in curves with radii between 300 m and 500 m. They can be utilised similarly to Jakob-bogies of articulated vehicles, but in contradiction to them they are independent of the type of carbody coupling and guaranty a fast uncoupling of the individual cars for maintenance purposes.

Bogies and running gears with radial steering wheel sets clearly surpass the conventional design solutions, particularly on track with a high number of curves.

References

- [1] POLÁCH, O.: *Železnice a hluk - stav, perspektívy, možnosti*. In.: Proceedings „Člověk a doprava“, Loučeň u Nymburka 1993, part 2, pp. 91-104
- [2] HECHT, M.: *Kurvenkreischen - Ursachen und Gegenmassnahmen*. Schweizer Eisenbahn-Revue, No. 3/1995, pp. 103-108
- [3] THOMPSON, D. J.; JONES, C. J. C.: *A review of modelling of wheel-rail noise generation*. Journal of Sound and Vibration (2000), No. 3, pp. 519-536
- [4] POLÁCH, O.: *Lok 2000 aneb vysoké rychlosti na švýcarský způsob*. In.: Proceedings „železniční vozidla“, Loučeň u Nymburka 1992, part 2, pp. 111-115
- [5] POLÁCH, O.: *Švýcarská lokomotiva SBB 460*. Železnice, No. 5/1993, pp. 16-17
- [6] POLÁCH, O.: *Optimierung moderner Lok-Drehgestelle durch fahrdynamische Systemanalyse*. Eisenbahningenieur (53), No. 7/2002, pp. 50-57
- [7] POLÁCH, O.: *Pojezdy a kolejová vozidla firmy SLM pro atraktivní regionální dopravu*. In: Proceedings of the 13th International Conference Current Problems in Rail Vehicles, Česká Třebová 1997, pp. 41-51
- [8] MEIER, B.; POLÁCH, O.; GROSSENBACHER, Th.: *Leichtbau-Fahrwerke für den Regionalverkehr*. Schweizer Eisenbahn-Revue, No. 7-8/1998, pp. 306-312, Eisenbahn-Revue International, No. 7-8/1998, pp. 306-312
- [9] MEIER, B.; POLÁCH, O.: *Erfahrungen mit Leichtbau-Fahrwerken für den Regionalverkehr*. In: Proceedings of the 4th International Conference on Railway Bogies and Running Gears, Budapest 1998, pp. 37-46
- [10] POLÁCH, O.: *Coupled single-axle running gears - a new radial steering design*. Proceedings of the Institution of Mechanical Engineers, Part F, Journal of Rail and Rapid Transit, 216 (2002), No. F3, pp. 197-206
- [11] POLÁCH, O.; MEIER, B.: *Erprobung der Einzelachsfahrwerke FEBA*. In: Proceedings of the 14th International Conference Current Problems in Rail Vehicles, Žilina 1999, Vol. 2, pp. 67-74
- [12] POLÁCH, O., KRAFT, D.: *Gekoppelte Einzelachsfahrwerke FEBA mit Radialeinstellung erfolgreich erprobt*. Eisenbahn-Revue International, 1999, No. 10, pp. 424-429