

5

Jean-Yves Monfort - Klemens P. F. Adler
Hans-Wilhelm Gierlich - Joachim Pomy
**MULTIMEDIA QUALITY AS PERCEIVED
BY THE USER**

11

Lubica Blaskova - Jan Holub
**HOW DO NON-NATIVE LISTENERS
PERCEIVE QUALITY
OF TRANSMITTED VOICE?**

15

Tatiana Kovacicikova - Pavol Segec - Michal Bruncko
**STANDARDIZATION PATHS FOR NGN
IMS-BASED ARCHITECTURE**

19

Pavel Segec - Tatiana Kovacicikova
**CALL PROCESSING LANGUAGE (CPL)
- A TOOL FOR CREATION OF INTERNET
TELEPHONY SERVICES BY THE END
USER**

23

Zafirios S. Pantelis - Stavros A. Kotsopoulos
**A COMPARATIVE STUDY OF COVERAGE
ESTIMATION AND QUALITY OF SERVICE
FOR DVB-H URBAN NETWORKS USING
A SPECIALIZED RF PLANNING
SOFTWARE**

29

Yejian Chen - Hardy Halbauer - Stephan Saur
Frank Schaich
**WIMAX PERFORMANCE IMPACTS IN
MULTI-CELL DEPLOYMENTS**

38

J. S. Vardakas - V. G. Vassilakis - M. D. Logothetis
**PERFORMANCE MODELLING AND
ANALYSIS OF PASSIVE OPTICAL
NETWORKS FOR POISSON TRAFFIC**

45

Ronny Henker - Andrzej Wiatrek - Kai-Uwe Lauterbach
Markus Junker - Thomas Schneider - Max J. Ammann
Andreas T. Schwarzbacher
**A REVIEW OF SLOW- AND FAST-LIGHT
BASED ON STIMULATED BRILLOUIN
SCATTERING IN FUTURE OPTICAL
COMMUNICATION NETWORKS**

53

Svetlana Andjelic - Slobodan Obradovic
Branislav Gacesa
**A PERFORMANCE ANALYSIS OF THE
DBMS - MySQL vs PostgreSQL**

58

Dusan Sabol - Jozef Dubovan - Miroslav Markovic
Milan Dado
**INVESTIGATION OF SOME ISSUES OF
FULL OPTICAL MULTIMEDIA NETWORKS**

64

P. Mandl - P. Schrotter - E. Leitgeb
**OPTICAL, WIRED AND WIRELESS MULTI-
MEDIA SERVICE ACCESS SOLUTIONS
FOR TREND SETTING REAL ESTATES**



Dear readers,

Communication technologies and communication networks nowadays feature a very rapid development in the world-wide context. Huge spreading of optical communications systems offers almost an unlimited broad band. Network convergence follows the ancient dream of network operators to unify communications environment on a platform unified from the technological, architecture and service points of view.

Hand-to-hand with the new technology development new services are more and more requested. The new services have, and will have a multimedia character.

Regardless of rapid development of communications technology it is necessary to keep in mind that the network is only a means for service conveying and its main aim, due to the new network technology and environments development, is provision of communication services. And services, their quality and reliability will have to dominate.

The first part of this issue of the journal focuses therefore on the quality of provided services. New services cannot be provided in a reliable way without a close feedback from the normalisation process. Readers can find some information about NGN/IMS technology normalisation in the next paper. The journal also presents current research activities in the areas of technologies, such as, for example, fix, optical, and radio communication networks.

I would like to thank all the authors who sent their contributions to this issue.

Martin Vaculik

Jean-Yves Monfort – Klemens P. F. Adler – Hans-Wilhelm Gierlich – Joachim Pomy *

MULTIMEDIA QUALITY AS PERCEIVED BY THE USER

End-to-end voice quality as perceived by the user has always been of major concern to ETSI, the European Telecommunications Standards Institute and its Technical Committee STQ (Speech processing, Transmission and Quality aspects). Recent developments in telecommunications increasingly promote the introduction of new services, including wideband speech communication and multimedia. At the same advent the global telecommunication landscape is undergoing dramatic changes, such as the migration from traditional public network operators to internet (or NGN) service providers.

This paper provides an insight into ETSI's activities for end-to-end multimedia quality for NGN - which is a promotional factor for the market. In a multi-vendor environment with quality not being regulated, standards are the only means to achieve reasonable end-to-end multimedia quality.

There will be a huge demand for wideband speech communication and multimedia in hands-free, mobile, nomadic and video phone applications in the near future. Devices designed for such applications will have to rely on non-linear and time variant signal processing in order to be capable of providing speech quality that satisfies users' demands. Therefore, it is essential to develop state-of-the-art requirements and test methodologies and to standardize them.

1. ETSI STQ - A Center of Excellence

Within ETSI, STQ is a center of excellence for end-to-end single media and multimedia transmission performance, QoS parameters for networks and services and distributed speech recognition, and takes responsibility for related standardization of terminals and networks. STQ has a charter stretching across ALL technology platforms and thus works in close co-operation with all ETSI and 3GPP groups involved in communication aspects; this charter also reaches out to other relevant organizations, such as ITU-T, TIA and IEEE. STQ Mobile, the working group on mobile services is creating standards on QoS aspects for popular services in GSM™ and Third Generation networks including picture and video quality; new working areas include aspects of Push-to-Talk over Cellular, MTSI (Multimedia Telephony Services over IMS), mobile broadcast and the definition of a reference web page in mobile QoS.

In order to facilitate this charter the members of the STQ leading team have committed to providing leadership also in ITU-T Study Group 12 because of the close relationship of both groups.

In summary, STQ's current activities are mainly focused on all quality aspects of multimedia.

2. Motivation for Multimedia Quality

Liberalization and competition, network inter-connection, the impending change to IP technology, real-time multimedia applications and services, have brought major changes over the last few years to the way quality for telecommunications is perceived by the user. The need for a framework to test, measure performance, and achieve Media Quality and Quality of Service (QoS) that takes into account these changes has become even more necessary.

In a multi-vendor environment standards are the only means to achieve reasonable end-to-end multimedia quality. STQ represents ETSI's commitment to end-to-end multimedia quality for NGN.

It is widely recognized that end-to-end multimedia quality is a promotional factor in the market. Generally, there is a lack of requirement standards for all the elements involved in a connection supporting high media quality and even though user behavior is changing and users are apt to accept low quality in certain situations (e.g. for private chats), there is also a strong demand for high quality in other situations (e.g. for business negotiations).

* Jean-Yves Monfort, Klemens P. F. Adler, Hans-Wilhelm Gierlich, Joachim Pomy

European Telecommunications Standards Institute (ETSI), Technical Committee Speech Processing, Transmission and Quality Aspects (STQ), Sophia-Antipolis Cedex, France, E-mail: jeanyves.monfort@orange-ftgroup.com
The authors jointly form the Leading Team of ETSI STQ.

3. Four Viewpoints of QoS

The QoS definition matrix of Figure 1 gives criteria for judging the quality of the communications functions that any service must support. However, even this definitional matrix can be viewed from different perspectives:

- Customer's QoS requirements (or expectations);
- Service provider's offerings of QoS (or planned/targeted QoS);
- QoS achieved or delivered;
- Customer survey ratings of QoS, i.e. the perceived QoS.

For any framework of QoS to be truly useful and practical enough to be used across the industry, it must be meaningful from these four viewpoints, which are illustrated below. While Figure 1 shows the "top down" relationship of these viewpoints, it does not indicate how, for example, QoS actually gets implemented by the service provider. This requires many detailed methods done in a more "bottom up" operation.

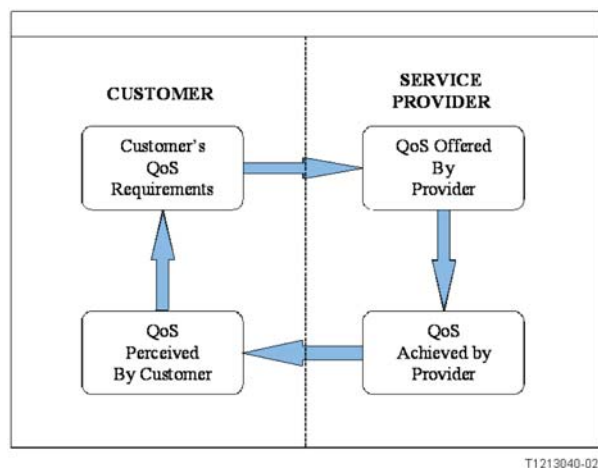

Fig. 1 The four viewpoints of QoS (from [1])

4. Quality as perceived by the User is a Promotional Factor in the Market

Users will compare the quality of new telecommunication services offerings with the quality they have experienced in the past as well as with other telecommunications service offers. For example, for a new video conferencing service users will compare this service offering to similar service offerings by other vendors but also they will compare it to other service offerings like a pure audio conferencing.

In addition users will compare the quality of multimedia services with the quality experienced in traditional entertainment services - this may be extremely critical for new wideband and super wideband audio services.

It is also of extreme importance to understand that users have individual thresholds for quality and that they, generally speaking,

will try new services only a few times (up to 3x) and if their finding is that the perceived quality does not match their individual thresholds, they will give up and not (i.e. never) try this service again.

Users' remembrance is static in contrast to the dynamic processes of service providers. One logical consequence of this is, that users may conclude: "This website is not useable - let's try the offer of the competitor..." despite any improvement efforts of the original provider.

This may lead to the conclusion for providers of new services that a migration strategy starting from lower quality and just aiming high quality might not be sufficient to satisfy users' demands.

5. Diffusion, Transmission Quality and Expectation for an Innovation

The diffusion theory is generally accepted for describing consumer behavior on the introduction of a new service [2].

The development of expectation in a new product (an innovation) can be analyzed with the help of the diffusion theory, details of this theory can, e.g. be found in [3] and [4]. Over many studies it has been found that the number of actual users of an innovation develops in an S shaped curve, see the first diagram of Figure 2. The time it takes to diffuse a product depends on many factors, so no scaling can be given. Different people proceed through the adoption process at different points in time. According to the adoption time, users can be divided into 5 classes, see Figure 2, second diagram:

1. *Innovators*: A very small group of persons who are very quick to purchase a new product or use a service. They are very willing to accept new technologies. Innovators have been found to be people with a higher income level, higher occupational status, and they are more socially mobile than other groups. Interestingly, they are not well integrated into social groups, so they do not rely on other's opinions as to whether products suit their own purposes.
2. *Early adapters*: A somewhat larger group following the innovators. They are still quick to purchase a product or use a service, but are much more integrated in their respective social group and believe in group norms. This is an aspect which seems to be apparent, e.g. for the early adapters of mobile telephones.
3. The *early majority*: These people enter the market next, but they are much less willing to take risks. About one third of all adapters belong to this group.
4. The *late majority*: This group enters the market when "newness" declines, so they are not really purchasing a new product or using a new service. They are less influenced by their corresponding social group behaviour and can be more easily influenced by advertisements.
5. The *laggards*: They enter the market when an innovation is already well accepted.

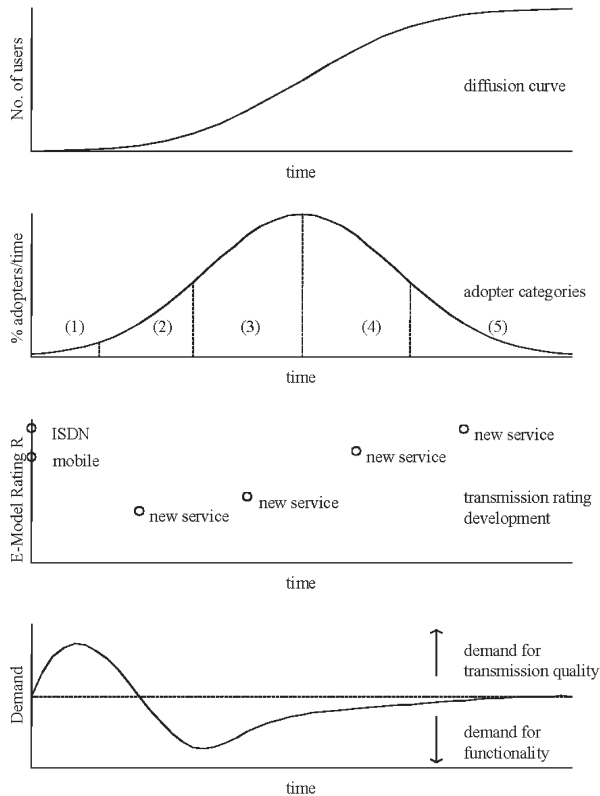

Fig. 2 Diffusion theory (from [2])

6. Where it All Begins: Real Communication Situation

When looking into users' perception of communication quality it is advised to go back to the real communication situation as it is present without technical means as depicted in Figure 3.

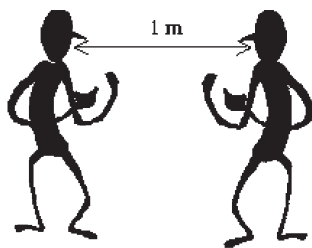

Fig. 3 Real communication situation between to human individuals

This situation has to be compared to the simulation or emulation of said situation by the means of a telecommunication system as depicted in Figure 4.

Although this classical example refers "only" to voice communication, it is easy to imagine similar comparisons for all kinds of media and multimedia communications. As one example, video on demand (VoD) will be compared by users to traditional televi-

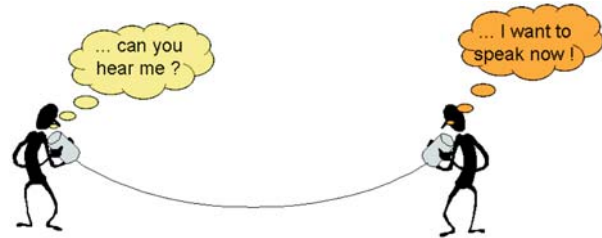

Fig. 4 Employing a telecommunication system

sion broadcast services and of course the flexibility of VoD will be honored by the user, whereas the video quality itself will be subject to a discriminating comparison with traditional TV.

7. Key Parameters affecting Multimedia Quality

In an IP environment multimedia quality will be affected mainly by the following parameters:

- Media Distortion
- End-to-End Delay
- Echo Effects
- Information Loss
- Distortion of Background Noise
- Loss of Synchronization between Media Streams

Media distortion can be recovered to a certain distinct in many cases; in detail this depends on the encoding scheme and other techniques involved. In contrast information loss which has the same root cause, can never be recovered - this is a serious problem for real-time multimedia business communication over IP. Furthermore, delay is a limited resource which is often wasted in the design of terminals or other signal processing equipment.

An increasing problem in network elements and terminals are signal processing devices which operate in tandem and thus create additional distortions (like artefacts) and delay. In order to minimize such - unwanted - quality degradations an information exchange logic and architecture concerning signal processing elements and their settings at (inter-) connection points is needed.

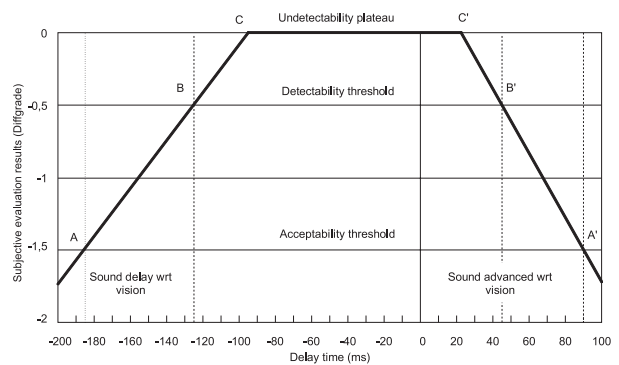

Fig. 5 Synchronization requirements (from [5]) for video and sound

A typical problem experienced in multimedia applications is the (lacking) synchronization between voice and video, see Figure 5.

Recently, German soccer fans could experience a situation where – due to a technical problem in the regular broadcasting regime – the sportscaster screamed “goal” while the viewers saw the ball somewhere in the middle field – and of course most users where unsatisfied with the (TV) service.

8. Impairments in packet networks

At each node in a packet network, packets are held in a queue awaiting transmission. Congestion causes longer queues than normal and so increases the transmission delay for the packets. Nodes also have limited queuing capacity and queues may overflow resulting in packet loss.

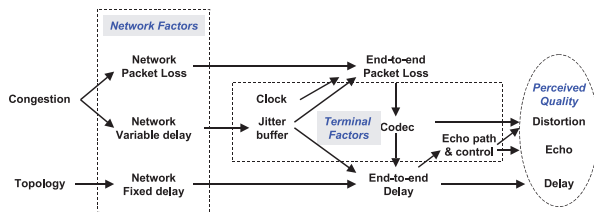

Fig. 6 Conjunction of network impairments and terminal impairments (from [6])

The terminals at the ends of speech circuits provide jitter buffering to smooth the play-out of packets. The jitter buffer is a storage of packets awaiting processing. The storage has a maximum size determined by the hardware, although the size used may be varied dynamically. The packets arrive at varying times and are extracted at regular intervals by the play-out algorithm. The effect of the jitter buffer is to convert variable delay into fixed delay. The fixed delay depends on the filling level of the jitter buffer. If the variable delay increases so that the buffer empties (called a jitter buffer under-run) then a packet is missed and cannot be played out. When variable delays reduce, the jitter buffers will fill up and if the maximum capacity is exceeded then packets will have to be discarded (called a buffer over-run). The play-out algorithm may be quite sophisticated and adjust the fill of the jitter buffer so that it is filled only to the extent necessary so that the probability of an under-run is low, so that the additional delay is minimized. In order to make these adjustments, packets may have to be skipped or duplicated introducing some additional distortion. Some highly intelligent algorithms may observe the values in the packets and make adjustments only when there are pauses in the speech flow. The different effects are shown in Figure 6. The important message here, again, is that the loss of information can be concealed but not recovered.

9. STQ Work on NGN Quality

All end-to-end Quality aspects for NGN have been moved from ETSI TISPAN to ETSI STQ, while TISPAN remains responsible for the architecture and signalling aspect to support end-to-end QoS. STQ has launched a roadmap on NGN related QoS and works – besides others – on the following topics:

- Performance Planning Guidelines for NGN Interconnect
 - NGN Interconnect Scenarios
 - End-to-End Performance Planning Guidelines for the PSTN Services in NGNs
- Audiovisual QoS for Communication over IP Networks
 - Access Technologies covered include both wired (e.g. xDSL) and wireless (e.g. UMTS, WLAN) technologies.
 - Display Size range covered is from those of small mobile terminals (e.g. 2”) up to large TV sets (e.g. 40” or more).
 - Applicable to Broadcasting and Streaming applications such as IPTV and VoD and Interactive point-to-point applications such as video telephony and videoconferencing.
- Requirements for Quality related Parameters at VoIP Interconnection Points
 - there is an urgent need in the industry for VoIP interconnect quality parameters and related requirements
- Provisional Responsiveness Thresholds for NGN Multimedia Applications from a User point of Perception
 - Possible use of the Apdex index

10. Four VoIP Terminal Standards

Four new standards specify terminal equipment requirements which enable manufacturers and service providers to deliver good quality end-to-end speech performance considering the essential requirements for the terminal equipment and their ability to handle impairments introduced by the network. These transmission requirements are drawn up from a QoS perspective as perceived by the user for

- Narrowband VoIP Terminals (handset and headset) [7]
- Narrowband VoIP Loudspeaking and Handsfree Terminals [8]
- Wideband VoIP Terminals (handset and headset) [9]
- Wideband VoIP Loudspeaking and Handsfree Terminals [10]

Besides the more traditional handset and desktop hands-free terminals also headsets, different types of hands-free communication devices ranging from handheld type to group audio terminals are considered. Furthermore setup and performance requirements for softphones are included.

A new approach was taken to make the requirements for the frequency response in sending and receiving direction more realistic; the basis is now the orthotelephonic reference response between two users in 1 meter distance under free field conditions, which is a new testing methodology developed in STQ; this methodology is compatible with the approach that has independently been taken for entertainment and multimedia devices. There are additional require-

ments for signal processing in terminals and new double talk performance requirements as well as new requirements for switching characteristics including echo cancellation tests.

11. Background Noise Transmission Quality

In modern communication the quality of the ambient background noise transmitted over the communication channel is of much more relevance than it was in the past. This is caused by three major developments:

- the increasing use of mobile and cordless devices with low D-values¹⁾, which pick up more background noise than a traditional standard terminal,
- the changing communication situations where users communicate no longer from a quiet home or small office but for example from the open-plan office, from the railway station or from the street - often with ear-deafening ambient noise,
- the increasing use and even tandeming of signal processing elements in network and terminals, such as comfort noise injection, automatic gain control or speech quality enhancement devices.

Background noise is present in most of the conversations today and it has the potential to impact the speech communication performance significantly. Therefore, testing and optimization of terminal and network equipment is necessary using realistic background noises. Furthermore reproducible conditions for the tests are required which can be guaranteed only under lab type condition.

In order to meet these challenges ETSI STQ has carried out an internal project with the support of external subjective test labs which resulted in an ETSI Guides with three parts:

- Background noise simulation technique and background noise database [11]
- Background noise transmission - Network simulation - Subjective test database and results [12]
- Background noise transmission - Objective test methods [13]

This project was funded by the European Commission since its results are essential for the high quality wideband communications of multimedia applications promoted by the EU, such as

- e-Government
- e-Health
- e-Learning
- e-Business

Based on this new standardized methods equipment manufacturers are now in the position to optimize the performance of their devices under realistic conditions based on objective test methods in the lab. Network operators and service providers are able to set minimum performance requirements based on typical use cases for their equipment which again can be defined based on the new ETSI STQ standards [11], [13].

Figure 7 shows the setup for realistic background noise simulation which can be used in labs, while Figure 8 shows a similar setup for cars. This setup can be used for all type of terminals including hands-free terminals.

The new objective test method described in [13] is based on a hearing model. It is more diagnostic than other objective speech quality tests methods since it provides in addition to the overall listening speech quality G-MOS (Global Mean Opinion Score):

- a mean opinion score purely focusing on the perceived speech quality in background noise S-MOS (Speech Mean Opinion Score) and
- a mean opinion score purely focusing on the perceived annoyance caused by background noise N-MOS (Noise Mean Opinion Score).

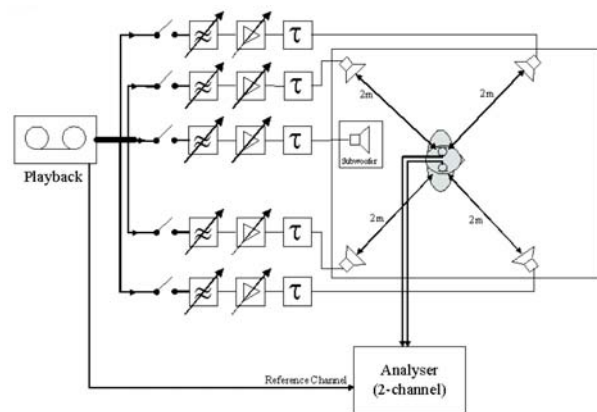

Fig. 7 Setup for realistic background noise simulation in a lab-type of environment

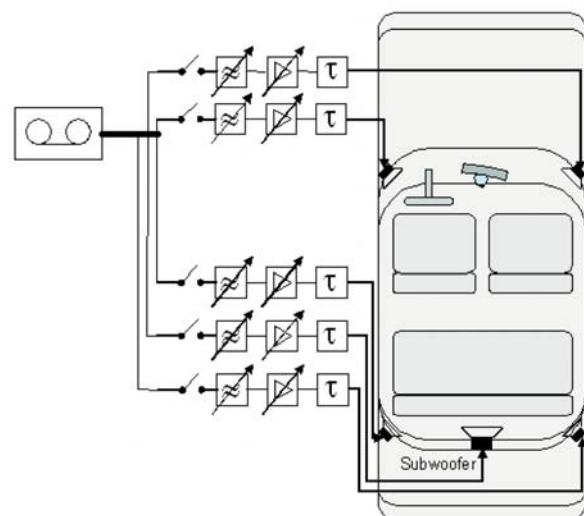

Fig. 8 Setup for realistic background noise simulation in a car

¹⁾ D-value is also referred to as Δ_{sm} , the difference in sensitivity towards diffuse noise compared with direct sound

The new objective model described in [12] is based on a huge database of a big variety of different speech samples with background noise which was investigated based on [14]. The details of the database as well as of the processing can be found in [13].

12. Conclusions

Generally, there is a lack of requirement standards for all the elements involved and interacting in a connection supporting high media quality. Even if users can deal relaxed with non-optimum quality in many cases, they have the expectation that high media quality is available to them once they demand it (and do not care so much about the actual costs). In response to these challenges

- STQ has published a report on basic issues concerning quality of speech over packet technology
- STQ is currently working on a standard for audiovisual QoS for communication over IP networks
- STQ has launched a roadmap on NGN related QoS standards to be developed in division of labor with ETSI TISPAN
- STQ has published four new terminal standards in order to enable manufacturers and service providers to enable good quality

end-to-end speech performance; the transmission requirements are drawn up from a QoS perspective as perceived by the user

- STQ has completed significant work on background noise and has developed a new methodology for testing background noise transmission.

In summary, with a charter stretching across all technology platforms STQ represents ETSI's commitment to end-to-end multimedia quality for NGN.

13 Three Excellent Reasons for Joining STQ

- Participate in the creation & improvement of standards for end-to-end media quality
- Share your own knowledge on media quality and make STQ even better
- Listen to the discussions during regular STQ sessions and special workshops & become part of the excellence. For immediate contact: info@etsi-stq.org.

References

- [1] ITU-T Rec. G.1000: Communications Quality of Service: A framework and definitions
- [2] ITU-T Rec. G.113: Transmission impairments due to speech processing
- [3] MOELLER, S.: *Assessment and Prediction of Speech Quality in Telecommunications*, Kluwer Academic Publishers, USA-Boston, 1991.
- [4] WILKIE, W. L.: *Consumer Behaviour*, John Wiley & Sons Inc., USA-New York, NY, 1994.
- [5] Draft ETSI DES/STQ-097: *Speech processing, Transmission and Quality aspects (STQ); Audiovisual QoS for communication over IP networks*
- [6] ETSI TR 102 430: *Speech Processing, Transmission and Quality Aspects (STQ); Basic Issues concerning the Quality of Speech over Packet Technology (both Internet and Next Generation Networks)*
- [7] ES 202 737: *Speech Processing, Transmission and Quality Aspects (STQ); Transmission requirements for narrowband VoIP terminals (handset and headset) from a QoS perspective as perceived by the user*
- [8] ES 202 738: *Speech Processing, Transmission and Quality Aspects (STQ); Transmission requirements for narrowband VoIP loud-speaking and handsfree terminals from a QoS perspective as perceived by the user*
- [9] ES 202 739: *Speech Processing, Transmission and Quality Aspects (STQ); Transmission requirements for wideband VoIP terminals (handset and headset) from a QoS perspective as perceived by the user*
- [10] ES 202 740: *Speech Processing, Transmission and Quality Aspects (STQ); Transmission Requirements for Wideband VoIP Loud-speaking and Handsfree Terminals from a QoS Perspective as Perceived by the User*
- [11] EG 202 396-1: *Speech Processing, Transmission and Quality Aspects (STQ); Speech quality performance in the presence of background noise; Part 1: Background noise simulation technique and background noise database*
- [12] EG 202 396-2: *Speech Processing, Transmission and Quality Aspects (STQ); Speech quality performance in the presence of background noise; Part 2: Background noise transmission - Network simulation - Subjective test database and results*
- [13] EG 202 396-3: *Speech Processing, Transmission and Quality Aspects (STQ); Speech Quality performance in the presence of background noise; Part 3: Background noise transmission - Objective test methods*
- [14] ITU-T Rec. P.835: *Subjective test methodology for evaluating speech communication systems that include noise suppression algorithm.*

HOW DO NON-NATIVE LISTENERS PERCEIVE QUALITY OF TRANSMITTED VOICE?

This paper describes the test methodology and results of speech transmission quality testing in the environment of non-native listeners; it means the communication language differs from the mother tongue of the test subjects. The tests were carried out based on ITU-T P.800 on a database of English speech samples affected by various coding distortions and background noise conditions. The subjects were pre-tested on their English proficiency. The subjective test results confirm a systematic and repeatable shift in subjective quality assessment performed by non-native listeners.

1. Introduction

In many practical cases, the communication in the telecommunication network is carrying a non-native language for one or more conversation participants [1]. There are procedures to automatically estimate perceived quality of the transmitted speech [3]-[5] and their results correlate well with subjective experiments carried on native speakers and native listeners. However, it is not clear if the effect of listener non-nativity can affect the quality perception. This paper examines methods to quantify such effects by presenting listening test results performed on non-native listeners, pre-sorted according their English proficiency.

1.1. Speech Transmission Quality Measurement

Speech transmission during any call in the telecommunication network is affected by many impairments; including delay, echo, various kinds of noise, speech (de)coding distortions and artefacts, temporal and amplitude clipping etc. Each transmission impairment has a certain perceptual impact on the speech transmission quality. The overall quality can be evaluated and expressed in terms of a Mean Opinion Score (MOS) covering the range from 1 (bad) to 5 (excellent). Speech transmission quality measurements are widely used to compare different coding and transmission technologies, or to monitor the network performance. The traditionally proven but expensive subjective methods [2], involving human listeners assessing many speech samples, have been partially replaced by objective digital signal processing algorithm based measurements that either compare the original undistorted signal to the received one [3] (so called intrusive or double-sided algorithms) or process only the received version [5]. All these methods have been designed and tested on past and contemporary telecommunication transmission standards that are widely used in common mobile and fixed telecommunication networks, e.g. those using 'toll quality' voice encoding.

1.2. Non-nativity as a Quality Perception Factor?

In many important practical cases, the communication in the telecommunication network is carrying a non-native language for one or more conversation participants. Typical examples are e.g. international and/or roaming calls in today's public fixed and mobile telecommunication networks or communications in military radio telecommunication networks during multi-national tactical operations [6], [7], international governmental organisations or multi-national companies. As the objective methods should be as accurate as possible replacements of subjective methods, the question of the influence of non-nativity to the final quality perception arises. Unfortunately, there are contradictory hypotheses about such an influence:

- Non-native listeners have higher difficulties to understand the contents even for less distorted samples than native listeners, thus they should assess quality worse (=giving generally lower scores) than native listeners.
- Non-native listener's brain is more occupied by message content decoding than in case of native listener, thus the quality assessment should not be so detailed, so some impairments can be missed, thus the final scores should be higher than for native listeners.

2. Work performed

2.1 Selection of Coders and Database Recording

A speech database fulfilling P.800 requirements and containing two background noise conditions (no noise/Hoth noise +10dB SNR) were recorded on selected coders (PCM 8 bit, GSM 06.10, MELPe 2.4 kbit/s). The final database contained 120 different sentences spoken by native English speakers. More than 2 female and 2 male speakers recorded in studio environment were used. In each case, 15 sentences per condition (noise+coder, see Table 1)

* Lubica Blaskova, Jan Holub

Department of Measurement, Faculty of Electrical Engineering, Czech Technical University, Prague, Czech Republic,
E-mail: l.blaskova@mesaqin.com, holubjan@fel.cvut.cz

were prepared. The active speech level as per ITU-T P.56 was equalized to -26 dBoV that corresponded then to 79 dB SPL (A) during the listening tests.

2.2. Selection of Listeners and their Language Proficiency Testing

Subjective tests were carried out on naive subjects as required by P.800. Their age was in the range between 20 and 30. None of them was a native English speaker, the nationalities represented in the group were: Czech, Slovak, Italian. The English proficiency of each subject was verified by a short quiz consisting of played-out English sentences/articles and followed by a set of questions to be answered on a written/multiple-choice principle. The language test lasted 7 minutes and was always performed right before the quality testing. The maximum achievable number of points in the language test was 21. Based on the language test results, the subjects were assigned to one of 3 categories:

- Beginners (0-3 points)
- Intermediate (4-10 points)
- Advanced (11-21 points)

The subjects were not informed about their results after the language tests.

2.3. Subjective Testing

Subjective tests as per ITU-T P.800 [2] were performed on the 120 sample database as described in 2.1. The subjective listening-only tests were performed in a critical listening room where up to 8 listeners could be seated. The reverberation time of the room is 185 ms and natural background noise less than 10dB SPL (A). The samples were played-back in random order by means of a digital playback system with SNR higher than 105 dB. The loudspeakers were actively compensated to achieve transition ripple less than 0.8 dB in an audible frequency range.

Multiple sessions were run always with different listeners. In total, 36 votes per sample were obtained, 13 per Beginners, 11 per Intermediate and 12 per Advanced groups.

2.4. Subjective Testing on Native Listeners

For verification purposes, similar subjective tests as described in 2.3 were performed using the same database but on native listeners. This experiment was carried out in Los Angeles, California, in April 2008. The test subjects were students of California State Polytechnic University, Pomona. The purpose of the test was to compare influence of (non-) nativity and different expectations of both groups of subjects, coming at the same time from different continents. Test subjects were seated in standard class room with only basic anechoic measures (plasterboard lining). The play-out system used non-compensated loudspeakers with transition ripple up to 9 dB in an audible frequency range.

3. Results

Test results are given in the following tables and figures. A special attention was paid to differences in quality perception between the Advanced group and the remaining two non-native (Intermediate and Beginners) groups. The per-condition results are listed in Table 1 and shown in Figure 1. Figure 2 shows results per sample. Both per-condition and per-sample results showed clear shift in subjective scoring of non-native listeners and the difference between Advanced and both other groups (Beginners and Intermediate) is about 0.5 MOS for the entire MOS scale. The difference between the Intermediate and Beginners is not so evident (not shown in the figures) and fits within confidence intervals of subjective experiments. The results of native listeners testing are reported in Fig. 3.

Due to different expectations driven by different communication technologies used in different countries and also due to different environmental conditions (room and equipment) the experimental results achieved on native and non-native listeners can not be directly compared. This is also well noticeable from Table 2 where Pearson correlation coefficients are reported. The results coming from native listeners provide significantly lower correlations with all other listener groups than in the remaining rows (where the results between two non-native listener groups are reported). Note that the correlation calculation is invariant to offset and gain changes so the systematic offset identified between Advanced and other non-native groups does not influence the results in Table 2.

Subjective test results (per condition) Table 1

Condition	Noise type	Coder	MOS-LQSn Advanced	MOS-LQSn Intermed.	MOS-LQSn Beginners
1	no noise	clean	4.38	3.78	3.88
2	no noise	PCM 8bit lin.	3.32	2.87	3.09
3	no noise	GSM 06.10	2.51	1.81	1.75
4	no noise	MELPe 2.4	2.87	2.58	2.44
5	10 dB Hoth	clean	3.55	2.74	2.61
6	10 dB Hoth	PCM 8bit lin.	2.75	2.35	2.36
7	10 dB Hoth	GSM 06.10	1.94	1.48	1.33
8	10 dB Hoth	MELPe 2.4	2.16	1.91	1.85

Pearson correlation coefficients between different listener groups ("per condition" results) Table 2

	Native	Advanced	Intermediate	Beginners
Native	1.000	0.670	0.789	0.758
Advanced		1.000	0.972	0.957
Intermediate			1.000	0.991
Beginners				1.000

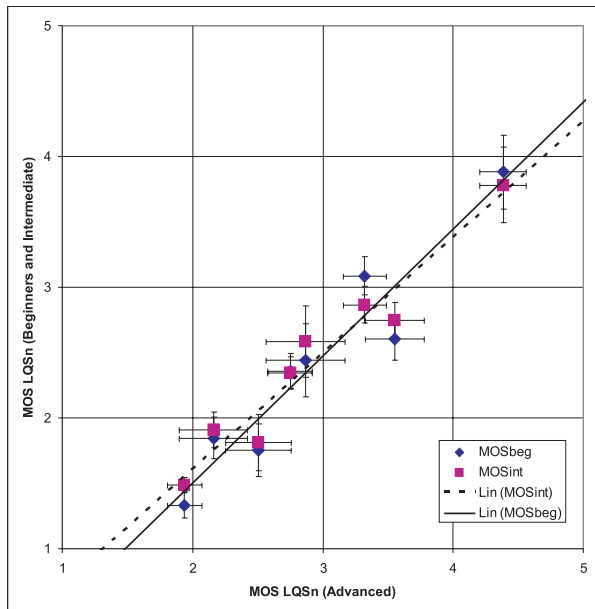

Fig. 1 Subjective test results per condition, comparison between Advanced and both other (Intermediate and Beginners) groups. 95% confidence intervals (CI95) are reported.

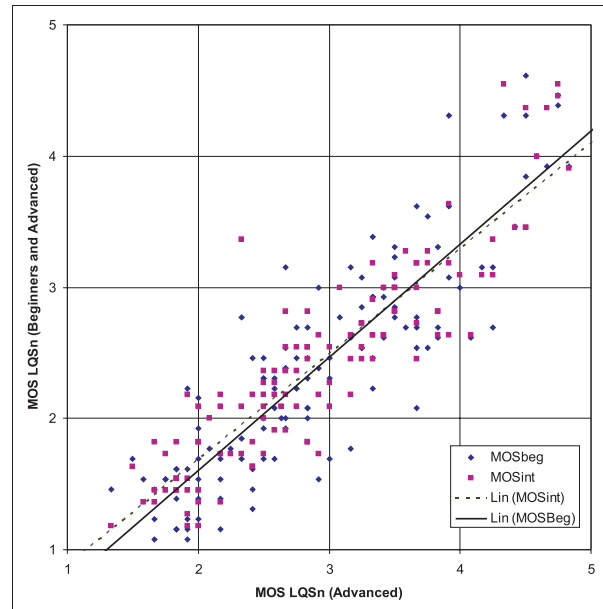

Fig. 2 Subjective test results per sample, comparison between Advanced and both other (Intermediate and Beginners) groups

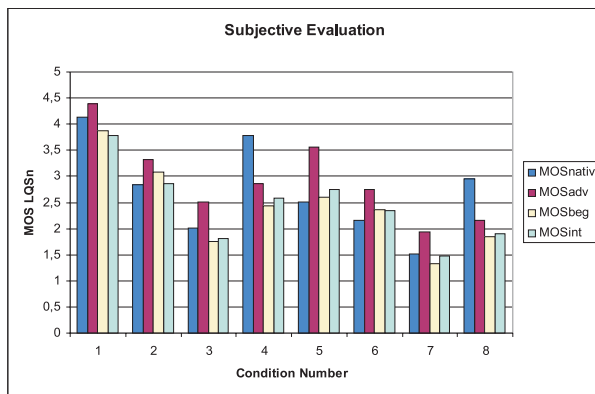

Fig. 3 Comparison between non-native and native listeners with different expectation factors

4. Conclusions

It is evident from the results that both non-advanced groups of non-native listeners (means Beginners and Intermediate) scored the samples systematically lower than Advanced listeners. It means

that the first hypothesis listed in Chapter 1.2 was confirmed. The offset is approximately 0.5 MOS along the entire MOS scale.

This systematic offset can be conveniently used to re-map PESQ or other objective algorithm output to bring the algorithm result closer to “conventionally correct” (meaning subjective) results in case the communication in the telecommunication network is carrying a non-native language for one or more conversation participants which occur e.g. during international and/or roaming calls in today’s public telecommunication networks or communications in military telecommunication networks during multi-national tactical operations. Such correction can impact significantly e.g. threshold-based decisions on link quality acceptability in automatic measurements performed by network monitoring systems or drive-test systems.

Acknowledgment

This work has been supported by the Czech ministry of Education: MSM 6840770014 “Research in the Area of the Prospective Information and Navigation Technologies”. The authors would like to thank Dr. Koichiro R. Isshiki from Cal Poly Pomona and Dr. Michael Street from NATO C3A for their valuable help and assistance.

References

[1] STREET, M. D.: *NGN in the Military Domain: NATO Network Enabled Capability (NNEC) and Networked Information Infrastructure (NII)*, RTO LS-070, paper 10, 2007.

- [2] ITU-T Rec. P. 800 *Methods for Subjective Determination of Transmission Quality*, International Telecommunication Union, Geneva, 1996.
- [3] ITU-T Rec. P. 862 *Perceptual Evaluation of Speech Quality*, International Telecommunication Union, Geneva, 2001.
- [4] PENNOCK, S.: *Accuracy of the Perceptual Evaluation of Speech Quality (PESQ) Algorithm*, MESAQIN 2002, Praha, CTU.
- [5] ITU-T Rec. P. 563: *Single-ended Method for Objective Speech Quality Assessment in Narrow-band Telephony Applications*, International Telecommunication Union, Geneva, 2004.
- [6] STREET, M, COLLURA, J.: *Interoperable Voice Communications: Test and Selection of STANAG 4591*, RTO-IST conf. on 'Military communications', Warsaw, Poland, 2001.
- [7] HOLUB, J., STREET, M., SMID, R.: *Intrusive Speech Transmission Quality Measurements for Low Bit Rate Coded Audio Signals*, AES115 Convention, New York, October 2003.

Tatiana Kovacikova – Pavol Segec – Michal Bruncko *

STANDARDIZATION PATHS FOR NGN IMS-BASED ARCHITECTURE

Thanks to the rapid development of technology and increased availability of bandwidth, today more than ever, multiple services such as voice, video and data can be integrated and efficiently carried over a single infrastructure based on a packet network. An NGN (Next Generation Network) is able to deploy those services independently from underlying transport-related technologies, giving fixed or mobile users an access to different providers with the adequate QoS and security. In fact, it is the IMS (IP Multimedia Subsystem) inside the NGN that enables and drives efficient converged service offerings. IMS provides the framework for a common service and session control layer standardized on IP, with SIP controlling all media sessions. The IMS standardization breaks down all the functions necessary to support multimedia applications and to provide standardized (open) interfaces towards application servers enabling enhanced premium services as well as the interworking with other (legacy) networks such as the PSTN/PLMN (Public Switched Telephone Network/Public Land Mobile Network). The paper is describing the current state of the art in the NGN standardization within the ETSI and related standardization bodies.

1. Introduction

The European Telecommunications Standards Institute (ETSI) defines fixed-mobile convergence as being concerned with providing network and service capabilities independently of the access technique. It is concerned with developing converged network capabilities and supporting standards. This does not necessarily imply the physical convergence of networks. These standards may be used to offer a set of consistent services via fixed or mobile access to fixed or mobile, public or private, networks. In other words, fixed-mobile convergence allows users to access a consistent set of services from any fixed or mobile terminal via any compatible access point. An important extension of this principle relates to roaming: users should be able to roam from network to network while using the same consistent set of services throughout those visited networks.

The full evolution to fixed-mobile convergence will be through the NGN (Next Generation Network) path. NGNs promise to be multiservice, multiprotocol, multi-access, IP-based networks: secure, reliable and trusted. The NGN framework is set by the International Telecommunication Union–Telecommunication Standardization Sector (ITU-T) and ETSI (European Telecommunications Standards Institute), especially its Technical Committee TISPAN (TC TISPAN) [1]. Other standardization organizations and fora such as the Internet Engineering Task Force (IETF) [2], 3GPP (Third Generation Partnership Project) [3], 3GPP2, American National Standards Institute (ANSI) [5], CableLabs [6], Multi-Service Forum (MSF) [7], and Open Mobile Alliance (OMA) [8] are actively involved in defining NGN standards.

In section 2, we provide a brief overview of the ETSI TC TISPAN (ETCI Technical Committee Telecoms & Internet converged Services & Protocols for Advanced Networks). In section 3, the emphasis is on NGN architecture principles and functions. Section 4 deals with the TISPAN NGN Releases and identifies steps in the standardization path towards the full NGN. Finally, conclusions are given in section 5.

2. ETSI TC TISPAN

The Technical Committee TISPAN is the ETSI core competence centre for fixed networks and for migration from switched circuit networks to packet-based networks with an architecture that can serve in both.

TISPAN is responsible for all aspects of standardization for present and future converged networks including the NGN, service aspects, architectural aspects, protocol aspects, QoS (Quality of Service) studies, security related studies, mobility aspects within fixed networks, using existing and emerging technologies. TISPAN is structured as a single Technical Committee, with seven Working Groups to deliver specifications back up to the TISPAN Plenary meetings.

3. NGN Architecture

TC TISPAN developed a functional architecture [9] consisting of a number of subsystems and structured in a service layer

* Tatiana Kovacikova, Pavol Segec, Michal Bruncko

Department of InfoCom Networks, Faculty of Management Sciences and Informatics, University of Zilina, Slovakia,
E-mail: Tatiana.Kovacikova@fri.uniza.sk

and an IP (Internet Protocol)-based transport layer. This system oriented architecture enables new subsystems to be added over time to cover new demands and service classes. It also provides the ability to import sub-systems defined by other standardization bodies. Each subsystem is specified as a set of functional entities and related interfaces. Fig. 1 shows the overall NGN functional architecture.

The transport layer provides the IP connectivity for NGN users. The transport layer comprises a transport control sublayer on top of transport processing functions in the access and core networks. Equivalent functionality in the User Equipment is defined in [9]. The transport control sub-layer is further divided into the Network Attachment Subsystem (NASS) and the Resource and Admission Control Subsystem (RACS).

The NASS provides registration at the access level and initializes terminal accessing to NGN services. More specifically, the NASS provides the following functionalities [10]:

- dynamic provision of IP addresses and other terminal configuration parameters;
- authentication taking place at the IP layer, prior or during the address allocation procedure;
- authorization of network access based on user profiles;
- access network configuration based on user profiles;
- location management taking place at the IP layer.

There may be more than one NASS to support multiple access networks.

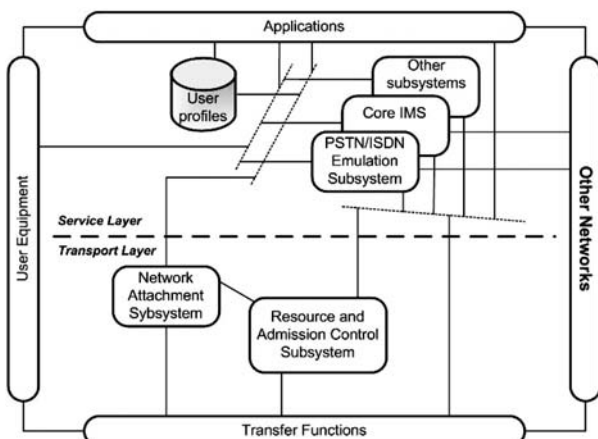

Fig. 1 TISPAN_NGN Overall architecture - Concept of subsystems

RACS [11] is the TISPAN NGN subsystem responsible for the implementation of procedures and mechanisms handling policy-based resource reservation and admission control for both unicast and multicast traffic in access networks and core networks. Besides acting as a resource control framework, RACS also includes support for controlling Network Address Translation (NAT) at the edge of networks and assisting in remote NAT traversal. Furthermore, RACS also covers aspects related to the setting and modification

of traffic policies, end to end quality of service and transport-level charging.

The NGN service layer comprises:

- Core IP Multimedia Subsystem (IMS)
- PSTN/ISDN emulation subsystem (PES) [5]
- IPTV subsystem (The TISPAN architecture also enables supporting IPTV services using the IP Multimedia Subsystem)
- Common components used by several subsystems (User Profile Server Function (UPSF); Subscription Locator Function (SLF); Application Server Function (ASF); Interworking Function (IWF)).

The core network of NGN Release 1 was based upon the IMS (IP Multimedia Subsystem), as defined in 3GPP Release 6 and 3GPP2 revision A for IP-based multimedia applications. IMS is a framework architecture – a definition of capabilities specified in a set of 3GPP documents that defines components, services and interfaces for NGN. It uses Voice over IP (VoIP) implementation based on a 3GPP standardized implementation of Session Initiation Protocol (SIP), and it runs over the standard Internet Protocol. 3GPP has enhanced the SIP and IP-based protocols (primarily Diameter) to allow for mobility. The TISPAN TC has adopted the IMS and is closely working with 3GPP on any modifications or improvements that may be needed for the NGN [11]. Moreover, the 3GPP IMS has been extended in the TISPAN NGN to support additional access network types, such as xDSL (x - Digital Subscriber Line) and WLAN (Wireless Local Area Network).

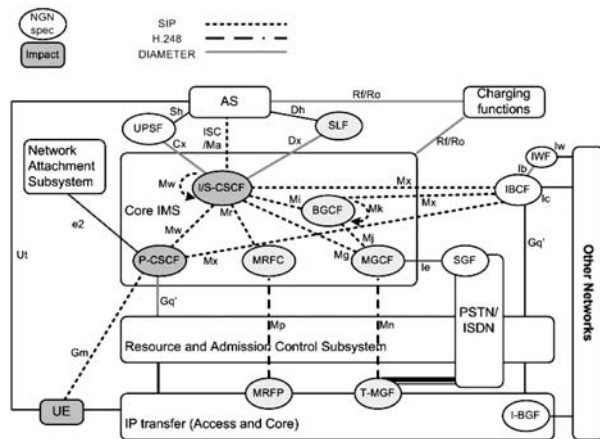

Fig. 2 Core IMS in the TISPAN_NGN

The core IMS functions [12] (Fig. 2) are included in the Call Session Control Function (CSCF) which is a SIP server which processes the IMS signalling traffic in order to control multimedia sessions. There are three types of CSCF:

- Proxy CSCF (P-CSCF): The initial point of contact for signalling traffic in to the IMS. A user is allocated a P-CSCF as a part of the registration process, and provides a two-way IPsec association with the user; all signalling traffic traverses the P-CSCF for the duration of the session.

- **Serving CSCF (S-CSCF):** Provides the service coordination logic to invoke and orchestrate the application servers needed to deliver the requested service. The S-CSCF interacts with the HSS in order to determine user service eligibility by downloading the user profile; the S-CSCF is allocated for the duration of the registration.
- **Interrogating CSCF (I-CSCF):** A SIP proxy that provides a gateway to other domains, such as other service provider networks. The I-CSCF may encrypt sensitive domain information a function referred to as Topology Hiding Internet Gateway (THIG) before forwarding the traffic.

Until Release 6, specifications for the P-CSCF included the Policy Decision Function (PDF), which stores policies and consults them to make decisions about IP bearer resource allocation requests. The PDF has been separated from the P-CSCF to make it more accessible to WLANs and other access network types. P-CSCFs also generate CDR (Call Detail Record) or billing records that can be consolidated at a Charging Gateway Function (CGF).

Common components are those that can be accessed by more than one subsystem. Two types of common components can be identified:

- Components known in 3GPP IMS
- New components defined by TISPAN.

The first group of components has been defined by 3GPP IMS. It includes the following functions:

- **Subscription Location Function (SLF)** is only needed when multiple HSSs (Home Subscriber Servers) are used. Within TISPAN, it can be accessed by service control subsystems and Application Server Functions to retrieve the identity of the UPSF (User Profile Server Function) containing the service-level user profile of a particular subscriber.
- **Application Server Function (ASF)** offers value added services and resides either in the user's home network or in a third party location. The third party could be a network or simply a stand-alone AS.
- **Interconnection Border Control Function (IBCF)** which provides the interconnection with other multimedia sub-systems.
- **User Profile Server Function (UPSF)** which is, in fact, a subset of the HSS defined by 3GPP. It stores all relevant information regarding the user, including identification, addressing, numbering, access controls and location information. Unlike HSS, UPSF does not provide HLR/AuC (Home Location Register/Authentication Centre) functionality.
- **Charging and Data Collection Functions:** As the names suggest, these provide data collection and billing mediation for online and offline charging.

The second group represents either new components that have been defined by TISPAN, or those 3GPP ones that have been modified by TISPAN in the context of NGN:

- **Application Server Function (ASF)** may provide standalone services or value added services on top of a basic session. For resource control purposes in NGN, the first category of Application Server Functions (ASF Type 1) may interact with the

RACS, while the second category (ASF Type 2) relies on the control subsystem that provide the basic session over which the valued added service is built. Examples of Application Server Functions are SIP Application Servers and OSA (Open Service Architecture) Application Servers. When sitting on top of the IMS, the second type of ASF (Application Server Function) is identical to the Application Server (AS) function defined by 3GPP, although a network node implementing this functional entity in an NGN network and a network node implementing it in a 3GPP network may differ in terms of supported services.

- **Inter-working Function (IWF)** is a new component that performs the inter-working between protocols used within TISPAN NGN service control subsystems and other IP-based protocols (e.g. between the SIP profile used in the IMS and other SIP profiles or IP-based protocols such as the H.323 protocol).
- **Charging and Data Collection Functions** include data collection functions and mediation functions to the billing systems (for supporting both on-line and off-line charging) or other management applications that may use the same data. It should be noted that charging in TISPAN Release 1 is limited to offline charging only.

4. TISPAN NGN Releases

NGN Release 1, published in December, 2005, provides the first set of implement-able NGN specifications that are being used by industry to build the NGN. It defines the overall architecture including IMS re-use and other subsystems.

NGN Release 2 is being completed. It builds upon Release 1 and adds in some initial applications such as Home gateway, IPTV and corporate networks. Release 2 architecture issues include new functionalities such as evolution of RACS including resource control in the core network and end-to-end QoS (Quality of Service) as well as evolution of NASS including additional access technologies, e.g., fixed access via xDSL (e.g. ADSL (Asymmetric Digital Subscriber Line), WLAN (Wireless Local Area Network) via xDSL (Digital Subscriber Line), WiMAX (Worldwide Interoperability for Microwave Access).

NGN Release 3 has been launched recently. As NGN networks are being rolled out and tested TISPAN is seeing a large increase in the number of corrections (CRs – Change Requests) to NGN Release 1 and Release 2. Some early requirements for the Release 3 include VoIP (Voice over IP) consolidation (including QoS, security, interworking), IPTV evolution, Ultra Broadband (fixed and wireless) access to the NGN and the interconnection (both IMS and non IMS).

5. Conclusion

The convergence between public switched telephone networks and IP based data networks forms a major part of the TISPAN work, along with the planning for the re-use in the fixed domain of the, originally mobile only, "IP Multimedia Subsystem" (IMS) developed in 3GPP.

IMS is the coming standards-based NGN architecture of choice for today's wireless, wireline and broadband operators. The primary driver behind IMS is a move away from circuit-switched services toward IP packet-based services. However, IMS will support both systems. And because the framework is access agnostic, IMS allows operators to continue to use different underlying network architectures.

IMS is expected to respond to and solve many of the industry's biggest technological challenges, including the lack of inter-

operability among operators who offer the same services and the inability of operators to take advantage of converged networks. However, IMS implementation should be viewed as a strategy of migration rather than replacement of an entire network. Operators can decide and choose which elements to implement, so the migration to IMS can be gradual. In other words, IMS can be viewed as a roadmap for operators that can guide them through an evolution to fully converged networks, services and technologies – a process that is already underway.

References

- [1] http://portal.etsi.org/Portal_Common/home.asp
- [2] <http://www.ietf.org>
- [3] <http://www.3gpp.org>
- [4] <http://www.3gpp2.org>
- [5] <http://www.ansi.org>
- [6] <http://www.cablelabs.com>
- [7] <http://www.msforum.org>
- [8] <http://www.openmobilealliance.org>
- [9] ETSI ES 282 001: NGN Functional Architecture.
- [10] ETSI ES 187 004: NGN Functional Architecture; Network Attachment Sub System (NASS).
- [11] ETSI ES 187 003: Resources and Admission Control Sub-system (RACS); Functional Architecture.
- [12] ETSI ES 282 007: TISPAN, IP Multimedia Subsystem (IMS): Functional Architecture.

Pavel Segec – Tatiana Kovacikova *

CALL PROCESSING LANGUAGE (CPL) – A TOOL FOR CREATION OF INTERNET TELEPHONY SERVICES BY THE END USER

Creation and programming new services are considered as crucial for the Internet telephony (IPT). A number of protocols have been defined for IPT, however, one of them – the Session Initiation Protocol (SIP) seems to be the most relevant thanks to its manifold features. The SIP offers many forms that can be used for programming new IPT services. One of them is to use the SIP baseline protocol mechanisms, the other – to define extensions to the baseline SIP protocol specification (defining new headers, new methods). Finally, the dedicated programming tools such as a Call Processing Language – SIP CPL, Common Gateway Interface – SIP CGI, SIP-servlets, Java applets, Java API for Integrated Networks – JAIN APIs, Parlay can be used for creation of new IPT services. In this paper we focus on one of the SIP IPT features allowing creation and control of IPT services by the end user himself – CPL (Call Processing Language).

1. Introduction

Internet telephony (IPT) is the future; the next generation of today's telephony. There is no doubt. The technology is mature enough and its implementation is rapidly growing around the world, blurring borders between Telco Providers and Internet Service Providers (ISP). On the one hand, IPT offers services very similar to services available in current Public Switched Networks (PSTN), on the other hand it offers many new features, which should be one of the key drivers of IPT. Wide opportunities for the creation of new, customer attractive services, based on the integration of telecommunication and data worlds, are undoubtedly among them. Controlling the process of service creation and programmability of services are crucial issues. Nowadays, there is a number of protocols defined for IPT, however, one of them – Session Initiation Protocol (SIP) [1], seems to be the most relevant thanks to its manifold features. The SIP is offering many forms that can be used for programming new IPT services. One of them is to use the SIP baseline protocol mechanisms, the other – to define extensions to the baseline SIP protocol specification (defining new headers, new methods). Finally, the dedicated programming tools such as Call Processing Language – SIP CPL, Common Gateway Interface – SIP CGI, SIP-servlets, Java applets, Java API for Integrated Networks – JAIN APIs, Parlay can be used for creation of new IPT services. It should be noted that SIP-based services can be programmed either by trusted (such as administrators), or by untrusted (such as end users) users. This model allows creation of services not only by providers of IPT network infrastructure, but also by third parties developers and the users themselves; this was not a case in the PSTN.

In this paper we focus on one of the SIP IPT features which allow creation and control of IPT services by the end user himself.

For this purpose a special programming language or tool – Call Processing Language (CPL) [2] – was developed for SIP. The CPL is not a tool for definition of new integrated services that combine telephony services with data services (email, instant messaging, presence etc). This is not its target. The CPL is a programming tool that provides the end user with the possibility to design and implement his own services. In other words, the user may define activities that influence a processing function of a SIP IPT server during call processing. End users can create and modify their own services directly, either manually via the CPL language definition, or by means of visual Graphic User Interfaces (GUIs) tools. In the latter case, the deep knowledge of the CPL language is even not required.

2. SIP (Session Initiation Protocol)

The SIP [1] is a signalling protocol developed to set up, modify and tear down multimedia sessions over the Internet. The SIP presents the Internet approach to voice and video communication over the Internet Protocol. The SIP provides signalling and control functionality for a large range of multimedia communications. The main functions are location of parties, invitation to service sessions, and negotiation of session parameters. To accomplish this, the SIP uses a small number of text-based messages, which are exchanged between the SIP peer entities, i.e., SIP User Agents. The SIP User Agents may operate as a client or a server depending on the role in a particular call. Messages can traverse through the SIP network entities like proxy servers or redirect servers that are used for support functions such as address resolution, routing calls to other entities, etc.

The SIP is a protocol that was designed to work hand in hand with other core Internet protocols. Many functions in a SIP-based

* Pavel Segec, Tatiana Kovacikova

Department of InfoComm Networks, Faculty of Management Science and Informatics, University of Zilina, Slovakia,

E-mail: Pavel.Segec@fri.uniza.sk

network rely on complementary protocols, for example, a Session Description Protocol for session definition, a Domain Name Service for addressing, a Real Time Transport Protocol (RTP) for media delivery etc. The SIP itself defines the initiation of a session only. The session itself is then described in two levels. The SIP itself contains the parties' addresses and protocol processing features, but the description of the media streams exchanged between the parties of a session is defined by another protocol. The Session Description Protocol (SDP) [3] is used for it. The SDP is not a protocol in the right sense, but rather a structured, text-based media description format that can be carried in the SIP message body. The message body is transparent to the SIP, thus, any other session description can be carried (e.g., a weblink, an e-mail address etc.). From this point of view, SIP sessions are not limited to telephony calls or conferences only, but they can also include information retrieval or broadcast sessions depending on the session description.

3. SIP services created by dedicated programming tools

The main aspect of programming SIP IPT service is the creation and implementation of a *service logic*, or just briefly a logic, into the IPT architecture. For this purpose any arbitrary programming language can be used in general. The logic is the used to influence and handle a specific signalling message flow or just to react on special conditions represented by special events, triggered by receiving a specific message or a header or an argument of a specific message.

Service logic can be added into each of the SIP entities (User Agent - UA, Proxy, Registrar and Redirect). In the case of extending UA, in opposite to SIP server entities, special kinds of problems are emerging that arise from specific implementation conditions (e.g. differences of end platforms, differences of UAs, issues regarding security and trustworthiness, etc.). The reason is that the UA is usually owned by the end user, not by the service provider. By implementing a logic into the SIP server entities, the logic controls and manages servers' activities based on specific input criteria, (e.g. callee or caller address, time of day, subject of a call and etc.). The logic may also instruct a server to route signalling, to create a new SIP request or a response message, or to add new headers. The basic model of implementing SIP service logic is provided in Fig. 1 [4].

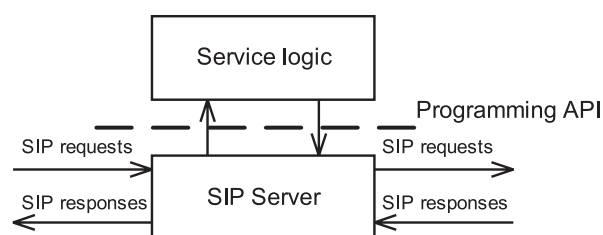

Fig. 1 The basic model of SIP service logic implementation.

The basic model supposes the extension of SIP server entities by a programmed service logic (application), where the logic is responsible for providing the main service with expected features. The logic and the server communicate through an application programming interface (API). In the moment when a specific message comes to the server (a specific event occurs), the SIP server passes the information to the logic. The logic, based on the received information and potentially on the other input information of the main service received from other sources (configuration of a service, database, directory services, etc.), makes a decision and instructs backward the SIP server about the actions it has to perform.

The model mentioned above is relatively simple; however, there are some issues that should be considered. One of them is the definition of the factor of safety or trustworthiness between a service application (i.e. service logic) and SIP entities (i.e. SIP server). The ratio of trustworthiness depends on the fact - who the creator of the service is. As mentioned earlier, a creator of a logic (i.e. a service) in the IPT can be either the owner of the infrastructure or a communication IPT service (highest trustworthiness, full access, trust user), or a third IPT service developer and provider (limited trustworthiness, limited access, untrusted user), or the end user (limited trustworthiness, limited access, untrusted user).

From the logic location point of view, the logic can be placed either in the SIP server itself, or in a separate, independent system. In the latter case some issues related to communications of those two independent systems have to be solved. In this case the role of the API interface takes over some specialized protocols - Remote Procedure Call (RPC) mechanisms or distributing computing platforms (CORBA, DCOM, etc.).

A model that may reuse a functionality of such a service layer (represented by programming interface) allows that a service simple uses the underlying network control and signalling infrastructure and significantly simplifies a process of development and implementation of new communication services. At the same time the model clearly stirs the old strict relations between the process of service development and a network infrastructure. This is allowed by mechanisms that use standardized service developing interfaces. The development of new communication services and applications is becoming simpler (from time, technology as well as economic points of view).

Development, portability and extendibility of new services is provided by standardized forms of APIs for IPT. Nowadays, a couple interfaces are defined, a part of them is derived from the interfaces that are used for development of web services. Each of them uses its own approach for service development. These interfaces allow creation of services to trusted users (SIP CGI, SIP-servlets, Java applets, JAIN APIs, Parlay) as well as to untrusted users (SIP CPL). Of course, there are also many proprietary APIs, however those APIs provide smaller portability of developed services. On the other hand, they often provide integrated solutions that allow better integration and usability of service components of the same company. However, some history events show that if a company producing such proprietary solutions would like to

keep their competitiveness, it cannot avoid the demand to implement such standardized interfaces. .

4. CPL (Call Processing Language)

The CPL (specified by the IETF in [2]) was one of first tools designated to support easily the development of IPT services. One of its main advantage is a fact that it is not strictly coupled with any of signalling protocols. The CPL is a programming tool which provides the end users with possibilities to create their own services, which is something unprecedented in old telephony systems. Using the CPL, a user may define activities which influence call handling activities performed by SIP IPT server during call processing.

The CPL is designed as a simple and easily extendible language, still enough flexible and powerful to provide means for flexible development of a wide range of services and its features. The CPL is taking into consideration that CPL services are developed and defined by end users, but they run on a network, in SIP providers' servers. Therefore, the CPL language has the performance and security limitations that ensure running the CPL service on providers' servers without the performance or security degradation of a network or a server. The main intention of the CPL is to provide the users with the ability to design, create and implement their own IP telephony services and to disallow the creation of complex, high performance and time consuming service processes. The CPL was designed to enable service providers to feel comfortable while making it available to semi-trusted users who could (through malice or incompetence) attempt to create invalid or ill-conceived service descriptions. For this reason, inside the CPL, the creation of program loops, starting up and calling up other processes or programs are not allowed. The CPL has neither defined any variables. The CPL is not a common programming language (compared to full featured, high-level programming languages such as Java, C/C++, etc.), it is more similar to scripting and markup languages (HTML, XML, and SGML).

The CPL has been based on the Extensible Markup Language (XML) that simplifies parsing of the CPL code by syntactic analyzers (i.e. parsers). The CPL is easily editable, either manually, via the CPL language definition (knowledge of CPL language and syntax is required) or through visual GUIs tools. In a latter case the deep knowledge of the CPL language is not required. It should be noted that the process of service creation is also available to users without the CPL knowledge. Definition of the service (design and creation) made by users corresponds to the creation of the CPL script (written manually or composed through the GUI). The structure of the CPL script corresponds relatively precisely to its behavior, so a syntactical rightness of the final CPL script can be easily verified by the CPL editor or the SIP server itself, even sooner than the script is put on a real service. Usage of the CPL service requires some methods of delivering the script from a user (i.e. creator of the service) to the SIP server. For this purpose, the SIP REGISTER method should be used. Other proprietary methods

are available, too (upload connections across IP network and placing script into a database).

A CPL script contains service ancillary information of the script and the information describing call processing actions performed during a call processing [2]. Ancillary information is the information that is necessary for a server to correctly process a script, but that does not directly describe any operations or decisions. Currently, no ancillary information is defined by the basic specification, but the special section is reserved for the future use by extensions. Information describing call processing actions is structured as a tree that describes the operations and decisions required to be performed by a SIP server in a case of a call set-up event. Call processing actions are divided in two types, top-level actions and subactions. Top-level actions are the actions that are triggered by signalling events that arise in the SIP server. Two top-level actions are nowadays defined by [2]. The first one is the incoming action, which is performed when a SIP INVITE message arrives on the server and whose destination address is the owner of the CPL script. The second one is, the outgoing action, which is performed when a SIP INVITE message arrives to that server whose originator is the owner of the CPL script. Subactions are the actions which can be called from other actions. CPL forbids subactions from being called recursively.

Call processing actions are abstractly described as a collection of nodes, each of which describes operations or decisions that should be performed or a choice that should be made. A node may have several parameters, which specify the precise behavior of the node. A node usually has outputs which depend on the result of the condition or the action of a node. Nodes are arranged in a directed acyclic graph, starting in a single root node. Outputs of the nodes are connected to additional nodes. When a CPL script is invoked and running the action or condition described by the node is performed, based on the result, the server follows one of the node's outputs and that action or condition is performed. This process continues until a node with no specified outputs is reached. Because the graph is acyclic, this will occur after a bounded and predictable number of nodes are visited.

Call processing actions consist of a hierarchical tree of nodes and its outputs which are described by XML tag. The CPL specification defines four categories of CPL nodes. Switches which represent choices a CPL script can make (decision made on address, time, string and priority). *Location modifiers* which control sets of location information. *Signalling operations* which cause events in the signalling protocol (e.g. proxy, redirect, route, reject). Last category is *non-signalling operations* that trigger behavior which does not effect the underlying signalling protocol (e.g. reading e-mail).

5. CPL service examples

Call Redirect Unconditional

This CPL script uploaded by some SIP user will unconditionally redirect all his call on the new user, identified with SIP address

sip: palo@sip.uniza.sk. Into the log file named "test" the following message will be put "Call redirect on: palo@sip.uniza.sk"

```
<?xml version="1.0" encoding="UTF-8" standalone="no"?>
<!DOCTYPE cpl SYSTEM "file:/home/cpl-01.dtd">
<cpl>
  <incoming>
    <log comment=" Call redirect on:
palo@sip.uniza.sk" name="test">
      <location url="sip: palo@sip.uniza.sk">
        <redirect />
      </location>
    </log>
  </incoming>
</cpl>
```

Fig. 2 Call Redirect Unconditional

Call screening

The following CPL script represents a SIP service where all call from anonymous callers, i.e. those who do not provide their name (Fig. 3).

```
<?xml version="1.0" encoding="UTF-8" standalone="no"?>
<!DOCTYPE cpl SYSTEM "file:/home/cpl-02.dtd">
<cpl>
  <incoming>
    <address-switch field="origin" subfield="user">
      <address is="anonymous">
        <reject status="reject" reason="I don't
accept anonymous calls" />
      </address>
    </address-switch>
  </incoming>
</cpl>
```

Fig. 3 Call screening

6. Conclusions

The CPL represents a light, simple but still powerful tool designated for creation of IPT services, especially by the end user himself. A CPL script, representing a SIP IPT service, is quite straightforward and relatively easy, especially with the use of available GUI tools. The CPL script is simple enough to analyze and verify its correctness (visually by a user, by a CPL editor, by a CPL SIP server). The CPL script natively cannot perform performance and security risky operations. On the one hand, it is suitable for IPT service providers to extend their IPT service portfolio; on the other hand, it allows end users to develop their services. These are the main CPL advantages.

In order to analyze CPL weaknesses, it is important to mention that the CPL is suitable for service creation, where the end user may influence only call control mechanisms performed during call processing in the SIP server. Using CPL is not able to create more complex, feature rich services, especially those which integrate different network services and features (localization, messaging, web, mail, chat, etc.). The CPL neither allows the cooperation with other programming languages. Apart from it, it is relatively complicated to integrate other software components (e.g. web services, mail services) into the CPL. The CPL does not provide users with the features that could enable creation of interactive services. In future, these limitations can be remedied by extending the CPL.

References

- [1] ROSENBERG, J., SCHULZRINNE, H., CAMARILLO, G., JOHNSTON, A., PETERSON, J., SPARKS, R., HANDLEY, M., SCHOOLER, E.: *SIP: Session Initiation Protocol*, RFC 3261, July 2002
- [2] LENNOX, J., SCHULZRINNE, H.: *Call Processing Language (CPL): A Language for User Control of Internet Telephony Services*, RFC 3880, October 2004
- [3] HANDLEY, J.: *SDP: Session Description Protocol*, RFC 2327, April, 1998
- [4] ROSENBERG, J., LENNOX, J., SCHULZRINNE, H.: *Programming Internet Telephony Services*, IEEE network magazine, June 1999

Zafrios S. Pantelis – Stavros A. Kotsopoulos *

A COMPARATIVE STUDY OF COVERAGE ESTIMATION AND QUALITY OF SERVICE FOR DVB-H URBAN NETWORKS USING A SPECIALIZED RF PLANNING SOFTWARE

The Digital Video Broadcasting - Handheld (DVB-H) standard is the ETSI standard for delivering broadcasting services of high data rates to handheld devices, under high mobility conditions. This paper will compare the different modulation techniques used by the DVB-H standard from the coverage point of view. The coverage estimation simulations have been made with a specialized RF planning tool using real Geographic Data for the metropolitan region of Athens. Thus, we will present a comparative study, of various planning factors like coverage percentage and location probability and compare them for the different modulation schemes used.

Keywords DVB-H, Coverage Estimation, RF network planning.

1. Introduction

Digital video broadcasting for handheld terminals (DVB-H) [1], ratified by the European Telecommunications Standards Institute (ETSI), is an amendment of the terrestrial DVB standard (DVB-T). It is based on the Internet protocol (IP) and implements additional transmitting techniques like Multi-Protocol Encapsulation Forward Error Correction (MPE-FEC) and time-slicing, giving the ability for power-limited handheld devices to support multimedia broadcasting services, under high mobility conditions. Thus, it is designed to encompass various contemporary telecommunication challenges such as low power consumption for the handheld receivers, better performance in difficult channel conditions and flexibility in network planning.

For our investigations we used Cellular-Expert of HMIT-BALTIC UAB, a specialized RF (Radio Frequency) planning software which in general implements propagation model algorithms applying them to various geographic data like Digital Terrain Models (DTM), buildings databases and others. The algorithms are based on the standard propagation models proposed and used so far for RF planning purposes (i.e. recommendation ITU-R P.526, Okumura-Hata model, Cost231 models etc.).

For the herein simulations we followed the planning guidelines from the ETSI DVB-H standard transcripts [2], [3]. Moreover, real geographic data for the metropolitan region of Athens have been used. Thus, we will present a comparative study for various planning factors, like coverage percentage and location probability, for a realistic scenario. Consequently, various network planning options will be pointed out.

This paper is organized as follows: In Section 2 a theoretical analysis for the DVB-H urban network coverage is presented. In Section 3 the proposed realistic urban scenario and the functionality of the RF planning software are described. Section 4 shows our simulation results, and analysis. Finally, concluding remarks are given in Section 5.

2. Theoretical analysis

It is necessary to introduce a theoretical approach for the coverage estimation of a DVB-H urban network before we elaborate on our study. Section 2.1 presents an arbitrary network configuration and the respective planning parameters deriving from the numerical values of the ETSI transcripts. In Section 2.2 the formulation of the propagation model used is described. Based on that, in Section 2.3 we estimate the network's coverage percentage in function with the transmitted power. Since we are interested only in the coverage estimation, as a preliminary study the simulations will be made over a single network cell.

2.1 Network Configuration

Modern digital telecommunication standards like DVB-H use orthogonal frequency division multiplexing (OFDM) and the respective modulation and coding parameters for signal transmission. The theoretical network is assumed consisting of one transmitter deploying the following planning parameters shown in Table 1 based on [2], [3].

* Zafrios S. Pantelis, Stavros A. Kotsopoulos

Wireless Telecommunications Laboratory, Department of Electrical & Computer Engineering, University of Patras, Greece Rion GR-265 00, Patras, Greece, E-mail: pzafeirh@ece.upatras.gr

Network Planning Parameters

Frequency	500 MHz
Bandwidth	8 MHz
OFDM transmitting mode	2K
Guard Interval	1/4
MPE-FEC code rate	3/4
Transmitter antenna height	21 m
Transmitter antenna type	Omni directional
Reception Mode	Portable Indoor, Class B
Integrated Receiver Antenna Gain	-12 dBd
Receiver Noise Floor	-102.5 dBm
Receiver Noise figure	6 dB
Additional Losses (GSM reject filter, man made noise, etc.	1.2 dB
Cell Radius	2 Km

Tab. 1

Next we estimate the minimum receiver power levels (P_{min}) for each different OFDM modulation scheme of the DVB-H standard. According to [4], [6], using Equation (1) we can calculate P_{min} from the C/N_{min} (Carrier to Noise Ratio) values denoted on [3]. Those values represent the minimum required C/N ratios in order to meet a degradation criterion for the network performance, given the modulation level.

$$P_{min} = P_n + C/N_{min} + N - Ga + L_{others} + F \quad (1)$$

where

P_n : Receiver Noise Floor

N : Receiver Noise Figure

Ga : Integrated Receiver Antenna Gain

L_{others} : Additional Losses

F : Location correction factor

C/N_{min} : Minimum required C/N ratio

The degradation criterion suitable for DVB-H is the MPE-FEC frame error rate (MFER), referring to the error rate of the time sliced burst protected with the MPE-FEC. Since DVB-H signal carries IP packets, an erroneous frame will destroy the service reception for the whole interval between the bursts. In other words there will be no service although some frames have received correctly. Thus, it is appropriate to fix the degradation point to the frequency of lost frames. MFER is the ratio of the number of erroneous frames (i.e. not recoverable) and total number of received frames. To provide sufficient accuracy, at least 100 frames shall be analyzed.

$$MFER[\%] = \frac{\text{Number of Erroneous Frames} \times 100}{\text{Total Number of Frames}}$$

It has been agreed that 5% MFER is used to mark the degradation point of DVB-H service. The minimum CNR values, in order the network performance meet this degradation point, are derived from [3] based on simulations and measurements of the ETSI DVB-H verification task force. For the case of portable indoor channels, which will be our mode of study, the minimum CNR

performance is shown in Table 2. Consequently, for our investigations we consider that the DVB-H network provides sufficient coverage when the predicted received signal meets the estimated minimum received power level.

For planning purposes we must also take into consideration the macro-scale signal variations by introducing an additional Location correction factor F which corresponds to the respective location probability. With the term "location probability" we mean the localized signal level variations that account for changes in the propagation environment which are not explicitly considered in the propagation model. Put another way, location probability refers to the spatial statistics of local ground cover variations including multipath variations [5]. Since these variations are considered to follow a normal distribution [3], [5], [8] we introduce a fade margin (or as referred previously a Location correction factor) F in order to evaluate higher location probability percentages thus higher Quality of Service (QoS). This is clearer in Figures 8 and 9. The fade margin is strictly connected with the standard deviation of the normal distribution. In our studies we will consider this fade margin as a relaxed factor in order to examine all the possible location percentages. The location correction factor at indoor locations is the combined result of the outdoor variation and the variation factor due to building attenuation. These distributions are expected to be uncorrelated. The standard deviation of the indoor field strength distribution can therefore be calculated by taking the root of the sum of the squares of the individual standard deviations [4]. As a consequence, the location variation of the field strength is increased for indoor reception. For the UHF (Ultra High Frequency) Band, where the macro-scale standard deviations are 5.5 dB [5] and 6 dB [3] for outdoor and indoor respectively, the combined value is 8.1 dB. This leads to a fade margin of 4, 10.5, and 14 dB for 70%, 90%, and 95% location probability

DVB-H C/N_{min} (dB) and P_{min} (dBm) in mobile channel Tab. 2

Modulation	Code rate	C/N_{min} (dB)	P_{min} (dBm)
QPSK	1/2	7.00	-81
QPSK	2/3	10.00	-78
16-QAM	1/2	13.00	-75
16-QAM	2/3	16.00	-72
64-QAM	1/2	17.00	-71
64-QAM	2/3	20.8	-67.2

Minimum threshold (dbm) for given location probability Tab. 3

Modulation	Threshold (dBm)		
	70%	90%	95%
QPSK 1/2	-77.00	-70.50	-67.00
QPSK 2/3	-74.00	-67.50	-64.00
16-QAM 1/2	-71.00	-64.50	-61.00
16-QAM 2/3	-68.00	-61.50	-58.00
64-QAM 1/2	-67.00	-60.50	-57.00
64-QAM 2/3	-63.20	-56.70	-53.20

respectively [3]. Adding those margins to the previous calculated thresholds will result to the variables of Table 3 which will be used for our simulations.

2.2 Propagation Model

In order to estimate the receiving power, the transmitting power and the signal attenuation are needed. The extended Okumura-Hata propagation model of the International Telecommunications Union (ITU) [5] will be used. Using an empirical propagation model provides a simple method for fast calculation of the receiving power. The results will be compared to simulation results using a more sophisticated (semi-empirical) propagation model described in Section 4 in order to show the practicability of the simplified method.

In Equation 2 the general propagation calculation is given. The parameter f [MHz] specifies the transmitting frequency, hb [m] specifies the transmitter antenna height, hm [m] is the receiver antenna height and r [km] specifies the distance between transmitter and receiver. For the calculations we assume that the receiving antenna height it at 1.5 m.

$$Loss(r) := 69.55 + 26.16 \log(f) - 13.82 \log(hb) - a(hm) + n \cdot \log(r) \tag{2}$$

where

$$a(hm) := (1.1 \cdot \log(f) - 0.7) \cdot hm - (1.56 \log(f) - 0.8)$$

$$n := 44.9 - 6.55 \cdot \log(hb)$$

2.3 Coverage Percentage Estimation

Now we can estimate the coverage percentage within the cell radius for each OFDM transmitting modulation modes and for various location probability targets. According to [8] the percentage of useful service area $U(\gamma)$ (i.e. the percentage of area with a received signal that is equal or greater than a threshold value γ) can be found by equation (3):

$$U(\gamma) = \frac{1}{\pi R^2} \int_0^{2\pi} \int_0^R P[P_r(r) > \gamma] r dr d\theta \tag{3}$$

where R is the cell Radius

Expression $P[P_r(r) > \gamma]$ of Equation (3) denotes the probability that the received signal at a given distance r will exceed a certain value γ . This term is also referred to as "location probability". Since we assumed a normal distribution for the macro-scale variations with a standard deviation of 8.1 dB, using the values of Table 3 for γ we can calculate this location probability in function with the EIRP (Effective Isotropic Radiated Power) of the DVB-H transmitter as it is shown in Figures 1, 2 and 3. As it is obvious

from the figures an increase of the EIRP is mandatory in order to achieve the same coverage for a better location probability and higher modulation level. The grade of that increment follows a normal cumulative probability distribution.

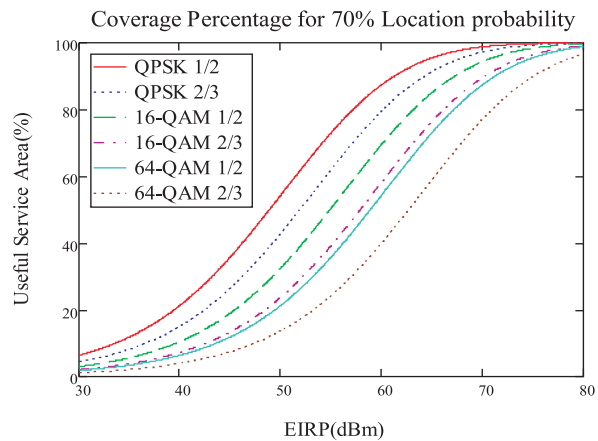

Fig. 1 Coverage Percentage for 70% Location Probability

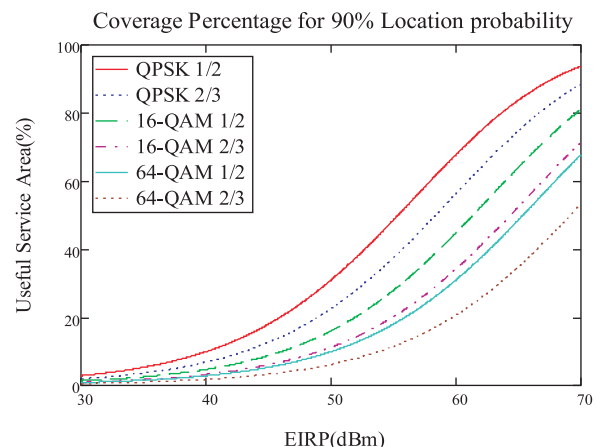

Fig. 2 Coverage Percentage for 90% Location Probability

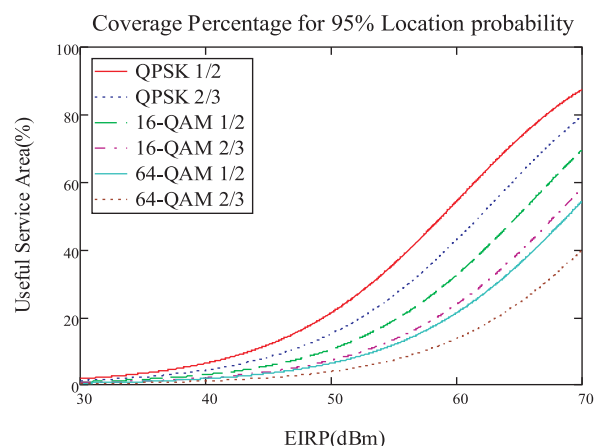

Fig. 3 Coverage Percentage for 95% Location Probability

3. Realistic Urban Network Scenario

In order to validate the theoretic results, a realistic urban DVB-H network scenario has been developed. According to this scenario a DVB-H base station transmitter will be placed on a building roof-top in the metropolitan region of Athens.

The DVB-H transmitter will be placed on a building of 21 meters height above ground level. The selection of the specific building is done in order to have a transmitter height above the average roof-top level. We also consider using an omni-directional antenna. The cell radius will be 2 km. This is because we want to have a uniform distribution of buildings around the transmitter so that the simulation results will be more reliable. We also consider a DVB-H 2K OFDM mode with a guard interval of 1/4. Thus, we follow the same parameters as in the previous theoretical approach.

3.1 Geographic Data

RF planning tools use geographic data in order to implement the propagation model algorithms over a certain area. Those geographic data are of great importance since the accuracy of the propagation predictions strictly depend on the accuracy of those geographic data. Generally there are 2 kinds of geographic data, raster and vector data. Raster data (or rasters) can be specified as a spatial data model that defines space as an array of equally sized "pixels" arranged in rows and columns, and composed of single or multiple bands. Each "pixel" contains an attribute value and location coordinates. Raster data usually represent terrain elevation or land use. Vector data store coordinates explicitly and generally represent building or streets structure. For our simulations we have at our disposal Digital Terrain Model (DTM) rasters for the terrain elevations of Athens area along with building vector data representing roof-top heights.

3.2 RF planning software functionality

In order to determine the coverage area of the DVB-H network cell, we use specialized RF planning software. As it has been discussed previously this software uses the available geographic data in order to apply certain propagation models. The result of this procedure is a raster, as it has been already described, in which each pixel represents this time the median predicted value in dBm, derived from the propagation model calculations. Thus, we can determine the regions over the cell having sufficient coverage by comparing these values with the minimum required threshold. Moreover, by entering the minimum thresholds for each modulation level shown in Table 3, the program gives us the ability to resolve the areas within the cell in which the respective modulation level is reached. Thus, we can estimate the cell coverage by post analyzing the simulation results in terms of counting the "pixels" that satisfy a certain threshold condition.

3.3 Propagation Model

The COST 231 Walfish-Ikegami propagation model [7] was selected for the receiving power estimation. It is verified for 800 to 2000 MHz and a cell radius up to 5 km. Similar to [6] it is also assumed to be valid for 500 MHz. This model is chosen due to its higher accuracy compared to empirical propagation models like Okumura-Hata or ITU-R Recommendation [5]. This is because it takes into account the propagation calculations the building databases which are available to us. For the calculations we assume that the receiving antenna height is at 1.5m above ground level.

4. Simulation results and analysis

Simulations for the DVB-H urban network scenario were performed with the above mentioned RF planning software using a range of transmitting powers for the EIRP of the DVB-H transmitter. Typical EIRP, used in broadcasting networks, extends from 30 W (≈ 45 dBm) to 30 kW (≈ 75 dBm). Since the EIRP is strictly connected with the cell radius, which for our study was being kept constant (2 km), the EIRP range for the performed simulations was narrowed up to 1kW (60 dBm). Figure 4 shows the prediction results over the DVB-H cell area. The map in Figure 4 displays 2 different levels, the prediction raster (colouring from red to green shades) and the building vector data (black and white shades). The colouring distribution of the prediction raster indicates the different receiving power levels starting from red (higher value) to green (lower value). This level displaying method gives us the ability to see the signal strength over any geographic data we choose. We can also see that the simulations were performed only on the buildings area adding to the prediction value a building penetration loss of 11 dB as indicated in [3]. The software gives us the ability to count the prediction raster pixels which meet a certain threshold condition. Thus, we can estimate the coverage percentage within the cell radius for various location probability targets. The RF planning software exports a 2 dimensional matrix $A_{m,n}$. The first column of the matrix contains the predicted values and

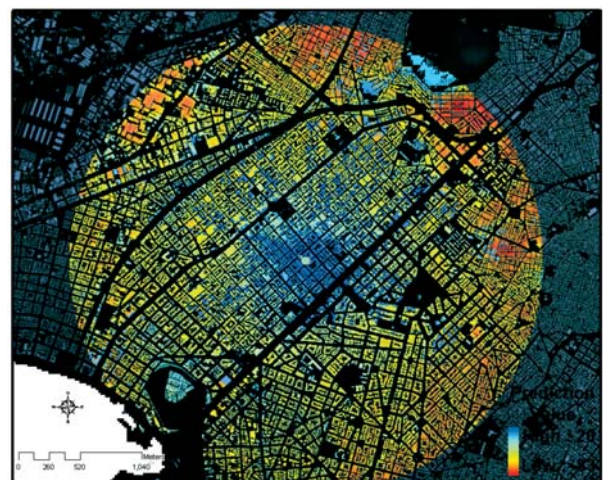

Fig. 4 Prediction Results over the DVB-H cell

the second one shows the number of prediction raster pixels having those values. Therefore, for our analysis Equation 3 that we used in the theoretical approach can be translated to the following Equation 4:

$$U(\gamma) = \frac{1}{S} \sum_{i=1}^m (A_{i,2}) P(A_{i,1} > \gamma), \quad (4)$$

where

m : matrix A rows

S : The total pixel number of the prediction raster

γ : certain minimum threshold

Factor $P(A_{i,1} > \gamma)$ of Equation 4 denotes the location probability for the predicted "pixel". In order to present our results for the post processed simulation predictions, we export the raster matrices described before for the simulations performed. Three nominal cases with transmitting EIRP of 40, 50 and 60 dBm respectively were taken into consideration. Using equation (4) and the threshold values of Table 3, we draw Figures 5, 6 and 7. In those figures we show the percentage of receiving locations within the cell which have a certain location probability for different modulation levels.

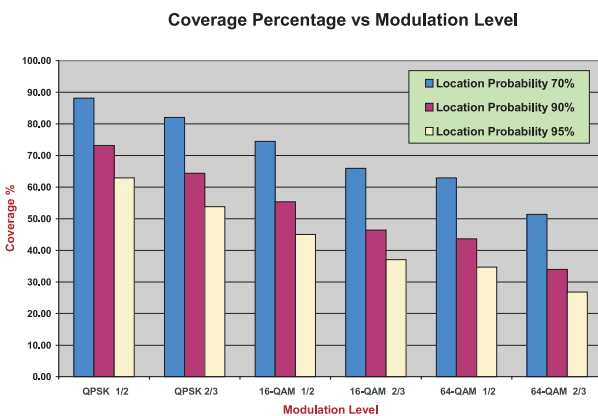

Fig. 5 Coverage Percentage for 60 dBm EIRP

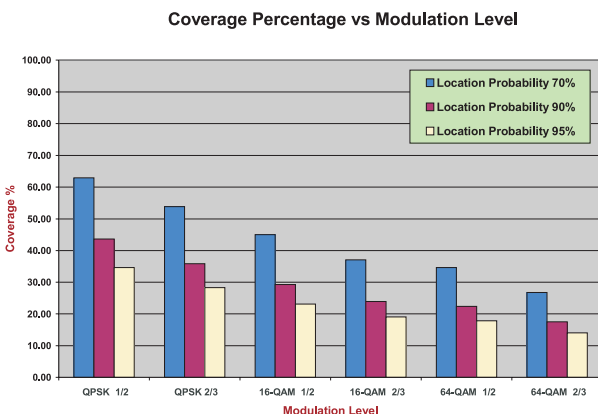

Fig. 6 Coverage Percentage for 50 dBm EIRP

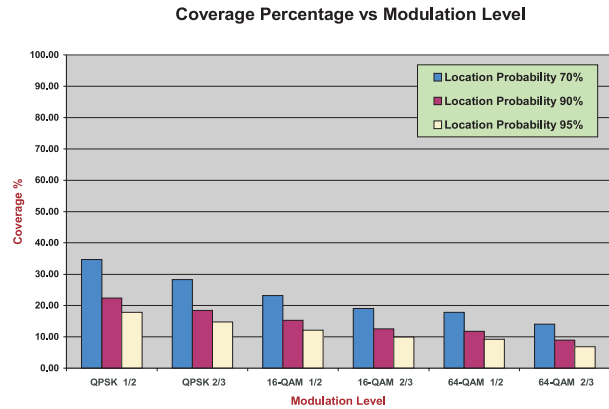

Fig. 7 Coverage Percentage for 40 dBm EIRP

The first obvious remark is that those results are in accordance with the theoretic results although we use a more accurate propagation model. The reason for that is the additional building penetration loss that we used making our semi-empirical propagation model as pessimistic as the empirical one. Secondly, we can observe that for both the theoretical and simulation results the coverage percentage follows a similar distribution in function with the EIRP, which resembles a Gaussian cumulative distribution function (CDF). We can also notice that the coverage percentage converge to 100% for different EIRP depending on the location probability targets. This remark can be a useful rule for the early stages of a DVB-H network planning in which only empirical propagation models are used. For a broadcasting network, coverage, is a grade for Quality of Services (QoS) provided. Thus we can use the above results rating the grade of coverage in both the dimensioning and optimization phase of the network planning. Furthermore, the method we described earlier for the estimation of coverage percentage from the simulation results, can be used as a general guide way for network planning tools, calculating coverage probability when a closed form function cannot be deduced from the propagation model formulation. Finally, the above theoretical and simulation results can be easily compared with actual signal measurements which present the realistic situation for the network coverage. These measurements can optimize the propagation models and coverage estimations through model tuning.

5. Conclusions

In this paper a comparative study for the coverage estimation of a DVB-H urban network is presented. The theoretical results using an empirical propagation model show a certain relation of the coverage percentage with the transmitting power. In order to validate the theoretical approach a realistic urban DVB-H network scenario in the metropolitan area of Athens was developed. As a preliminary study a single DVB-H cell was examined using an RF planning software, applying a highly accurate propagation model over existing high resolution geographic data. Thus, the same grade of relationship between coverage and EIRP was derived.

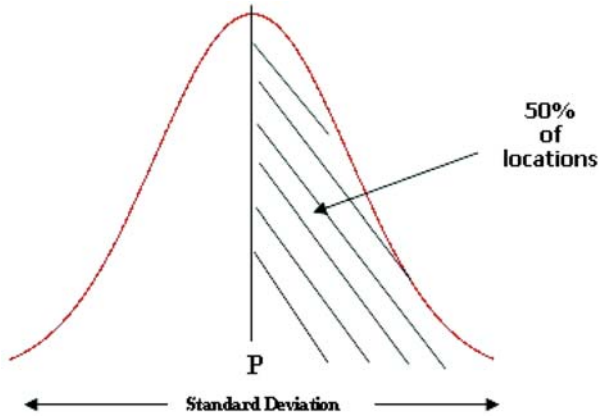

Fig. 8 Normal Distribution of a predicted median signal power level P

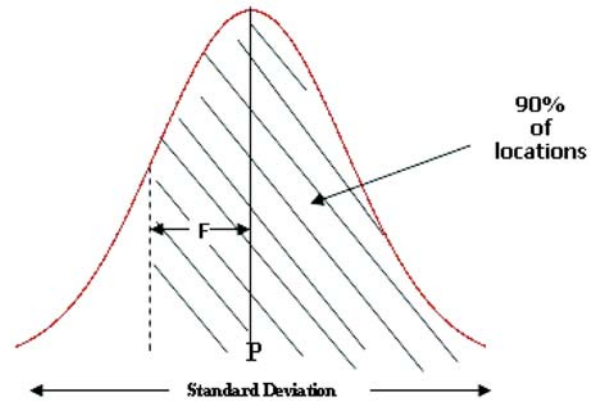

Fig. 9 Introduction of a Fade Margin F for higher location probability

6. Acknowledgments

This work was supported by HELETEL S.A. [9], HNIT-BALTIC UAB [10] and MARATHON DATA SYSTEMS [11].

References

- [1] Digital Video Broadcasting (DVB): *Transmission System for Handheld Terminals (DVB H)*, ETSI Std. EN 302 304 V1.1.1, November 2004.
- [2] Digital Video Broadcasting (DVB): *DVB-H Implementation Guidelines*, ETSI Std. TR 102 377 V1.2.1, November 2005.
- [3] Digital Video Broadcasting (DVB): *DVB-H Implementation Guidelines*, ETSI DVB Bluebook A092 rev.2 (draft V1.3.1), May 2007.
- [4] FARIA, G., HENRIKSSON, J.A., STARE, E., TALMOLA, P.: *DVB-H: Digital Broadcast Services to Handheld Devices*, Proc. IEEE 1/94, pp.194-209, 2006.
- [5] ITU-R Recommendation P.1546-1: *Method for point-to-area predictions for terrestrial services in the frequency range 30 MHz to 3000 MHz*.
- [6] UNGER, P. KURNER, T.: *Radio Network Planning of DVB-H/UMTS Hybrid Mobile Communication Networks*, European Transactions on Telecommunication, 2/17, pp. 93-201, 2006.
- [7] KURNER, T.: *Propagation Models for Macro-Cells*, in Digital Mobile Radio Towards Future Generation Systems (COST 231 Final Report), COST Telecom Secretariat, CEC, Brussels/Belgium, 1999, pp. 134-148.
- [8] RAPPAPORT, T. S.: *Wireless Communications Principles and Practice*, 2nd ed., ser. Prentice Hall Communications Engineering and Emerging Technologies Series
- [9] HELETEL, S. A. *homepage* <http://www.heletel.net>
- [10] HNIT-BALTIC UAB *homepage* <http://www.hnit-baltic.lt>
- [11] MARATHON DATA SYSTEMS *homepage* <http://www.marathondata.gr>

Yejian Chen – Hardy Halbauer – Stephan Saur – Frank Schaich *

WIMAX PERFORMANCE IMPACTS IN MULTI-CELL DEPLOYMENTS

This paper presents the application of the multiple antenna schemes beamforming (BF) and Multiple Input Multiple Output (MIMO) in the broadband wireless access system WiMAX. The evaluation considers the competing performance demands on link robustness and peak data rate. Configurations for both uplink and downlink are discussed. We conclude that future wireless communications will rely on diverse and adaptive multiple antenna schemes to meet their requirements, in particular in the presence of strong co-channel interference.

1. Introduction

The current standard IEEE 802.16e [1], base of the well-known WiMAX Mobile System Profile [2], provides Orthogonal Frequency Division Multiple Access (OFDMA) allowing efficient resource sharing and coping with multipath propagation in dense urban environments. OFDMA is also a dominant candidate for future 4G wireless communication systems. However, in cellular networks without explicit precaution co-channel interference causes severe performance degradation in terms of coverage and data throughput, particularly in systems with low frequency reuse factor.

WiMAX allows for the multiple antenna solutions beamforming and MIMO which can be exploited to improve radio links. Both approaches utilize more than one antenna element at the base station (BS) for both uplink and downlink, whereas the mobile terminal (MS) is equipped with two receive and one transmit antenna.

Beamforming is mainly used to increase the link budget and to coordinate or even to suppress interference. The basic principle of beamforming is a well-defined phase relation between the individual antenna signals, also referred to as complex beamforming weights.

The WiMAX profile includes MIMO modes with different objectives. In downlink 2×1 or 2×2 Space Time Transmit Diversity (STTD) intends to improve the link robustness by the use of Space Time Block Coding (STBC) according to the Alamouti principle. 2×2 Spatial Multiplexing (SM) is the alternative downlink operation mode. Hereby one user can be served by two independent data streams, thus boosting the overall data rate.

This article gives an overview of the state of the art of multiple antenna solutions. Firstly, in Section II the downlink transmission system is described. After the discussion of the most important functional blocks of a single radio link, the model of the cellular systems with multiple users is presented. Section III covers a detailed

performance evaluation on link level and on system level. The relative coverage and throughput improvements depending on transmission mode, antenna configuration and channel model will be given for some exemplary scenarios. Section IV describes two promising algorithms for receive beamforming in uplink before in Section V the interference suppression capability for different specific scenarios is analyzed by link level simulations. Finally, Section VI summarizes the most important results.

2. Downlink system model

In an OFDMA system, the subcarriers of each OFDM symbol are shared among several independent radio links. A certain number of subcarriers are summarized to one subchannel which is the smallest possible user allocation unit in frequency direction. The subcarriers belonging to one subchannel are either physically adjacent or distributed throughout the entire frequency band. In a WiMAX system, the first case is called Adaptive Modulation and Coding (AMC). It is designed for the application of frequency selective scheduling. The latter case is referred to as Partial Usage of Subchannels (PUSC, applicable both in uplink and downlink) and Full Usage of Subchannels (FUSC, downlink only). Both have the capability to exploit frequency diversity in frequency selective channels, i.e. in urban environments with significant delay spread. The WiMAX frame is structured in so called zones. Each zone consists of several OFDM symbols and is based either on AMC, PUSC or on FUSC.

In the following, we will describe the downlink system model in more detail.

A. Link level description

We now consider the radio link between BS and mobile terminal for one single user, i.e. the signal consists of a certain set of subcarriers in PUSC mode. Moreover, we assume a 2×2 MIMO

* Yejian Chen, Hardy Halbauer, Stephan Saur, Frank Schaich

Alcatel-Lucent Bell Labs, Lorenzstraße 10, D-70567 Stuttgart, Germany, E-mail: Yejian.Chen@alcatel-lucent.de

configuration. Fig. 1 shows a simplified block diagram of the transmitter.

The bits to be transmitted get FEC encoded. After QAM mapping either STBC coding or SM may be applied. Then the symbols are assigned to the used subcarriers of the OFDM symbols within the WiMAX frame. Finally, with the help of an IFFT the transmit signals are generated, and the cyclic prefix is added.

After transmission over the mobile radio channel, the receiver tries to estimate the transmitted bits from the received signals. The principle block diagram of the receiver is shown in Fig. 2. After transformation of the received signals with a FFT, the received data burst is collected. Diversity decoding is applied if STBC is active. Alternatively the data streams are separated if spatial multiplexing is used at the transmitter. After equalization and demodulation, FEC decoding is done.

transmit antenna number. n_1 and n_2 are independent Gaussian distributed complex noise samples with zero mean and variance $\sigma^2/2$ per dimension, where the index reflects the OFDM symbol, * denotes complex conjugation. A constant channel during the interval of two consecutive OFDM symbols and ideal channel knowledge at the receiver is assumed. A total power constraint is accounted for.

C. System level description

From the beginning, it was the intention of the IEEE 802.16e/WiMAX standard to enable multi-cell deployments including hand-over capabilities and frequency reuse within the network. The standard is inherently designed to support BSs with three sectors per site, covering 120 degrees each. This is also the configuration we analyze throughout this paper. With this deployment type, a frequency reuse factor of 3 (RU3) where each sector operates in a different frequency band is a natural approach.

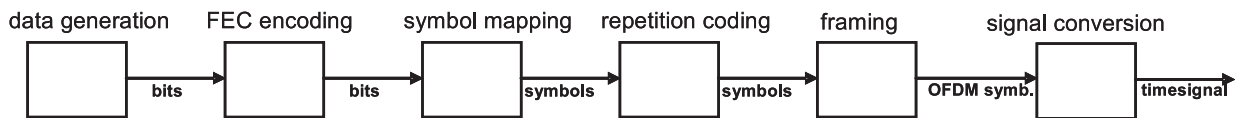

Fig. 1: Block diagram of the transmitter

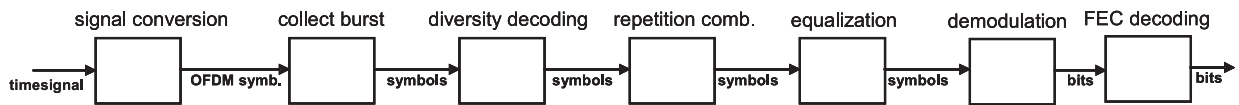

Fig. 2 Block diagram of the receiver

B. Downlink MIMO in WiMAX

A plethora of multi antenna schemes for downlink are defined in IEEE 802.16e [1]. To reduce complexity both in the BS and in the mobile terminal, the WiMAX Forum has selected two important schemes in its Mobile System Profile [2]. 2×1 and 2×2 STBC allow for increasing link robustness. The algorithm is based on the well-known Alamouti principle [3] and will be described roughly in the following. For SM performance studies and algorithm proposals, the interested reader is referred to [4, 5].

Let s_1 and s_2 be two complex QAM symbols to be transmitted in consecutive OFDM symbols on a single subcarrier. They are fed into the STBC encoder, which delivers four complex symbols at its output, one per transmit antenna and per OFDM symbol. After transmission over the channel, the receiver combines the received symbols to get:

$$\begin{aligned} \tilde{s}_1 &= (|h_1|^2 + |h_2|^2) \frac{1}{\sqrt{2}} s_1 + h_1^* n_1 + h_2^* n_2 = h_{eff} \frac{1}{\sqrt{2}} s_1 + n_{1,eff} \\ \tilde{s}_2 &= (|h_1|^2 + |h_2|^2) \frac{1}{\sqrt{2}} s_2 + h_2^* n_1 + h_1^* n_2 = h_{eff} \frac{1}{\sqrt{2}} s_2 + n_{2,eff} \end{aligned} \quad (1)$$

h_1 and h_2 are the complex channel coefficients between the transmit antennas and the receive antenna, where the index reflects the

For the assessment of performance metrics like coverage and data throughput in multi-cell scenarios, the system simulation methodology illustrated in Fig. 3 is used. This analysis includes effects of pathloss, antenna radiation pattern and interference from

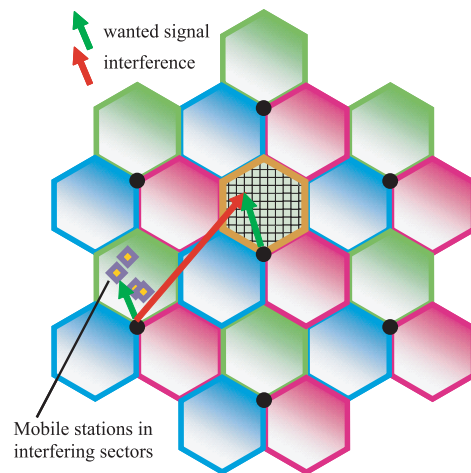

Fig. 3 Considered multi-cell deployment

neighboring cells assuming a certain frequency reuse factor. Also the impact of downlink beamforming can be investigated.

The deployment consists of 7 BSs and 21 sectors. The different colors indicate the used frequency band, i.e. in Fig. 3 we exemplify a RU3 system. The performance in terms of effective Signal-to-Interference-plus-Noise Ratio (SINR) is evaluated at the grid points in the center, green sector, also referred to as reference sector. Mobile terminals causing interference in the reference sector are located randomly in the neighboring sectors. One simulation considers a multitude of these Monte Carlo drops.

As link level simulations give the Packet Error Ratio (PER) for a certain Signal-to-Noise Ratio (SNR) value, the expected data throughput at each grid point and the coverage can be determined easily. The mean sector throughput is the average over the achievable throughput at each grid point of the reference sector. The coverage is the percentage of grid points at which transmission with a data rate above a certain threshold is achieved.

D. Multi-Antenna Configurations

Multi-antenna configurations at the BS can significantly reduce the impact of interference in a multi-cell deployment and improve performance. The configurations supported by the WiMAX Mobile System Profile [2] are

- MIMO
- dynamic beamforming
- combinations of MIMO and beamforming

Concerning interference behavior, the MIMO systems using sector antennas are similar to single antenna systems. In contrast, a beamforming array concentrates the transmitted energy in direction to the addressed user, thus a reduction of the interference in other directions is expected. Combination of MIMO and beamforming promises the benefits of both. Therefore the focus throughout this paper is on the comparative analysis of these configurations.

3. Downlink performance comparison

A. Impact of channel correlation on STBC performance

The channel coefficients h_1 and h_2 are time-variant and exhibit deep fades. The gain achievable with STBC is due to the fact that the effective coefficient h_{eff} from (1) is flattened compared to the original h_1 and h_2 , i.e. the probability of a deep fade is significantly reduced. Let Ξ_1 and Ξ_2 be the events of h_1 and h_2 being in deep fade. Then $P_{SISO} = P[\Xi_1]$ is the probability that the single link in the case of SISO fails. Applying STBC, two links between the transmitter and the receiver are present. The symbol transmitted is lost if both links are in deep fade. Therefore, the joint probability $P_{MISO} = P[\Xi_1, \Xi_2]$ quantifies the probability of losing a symbol during transmission. A simple conversion delivers $P_{MISO} = P[\Xi_1] P[\Xi_2|\Xi_1]$. In the case of uncorrelated links, $P[\Xi_2|\Xi_1] = P[\Xi_2]$ holds. Then we get $P_{MISO,uncorrelated} = P[\Xi_1] P[\Xi_2]$. The probability to lose a symbol is thus decreased compared to the SISO case. On the other hand, if the links are fully correlated, we have $P[\Xi_2|\Xi_1] = 1$, i.e. we get $P_{MISO,full\ uncorrelated} = P[\Xi_1]$. It follows

that the MISO system degrades to SISO performance in the case of full correlation. The probability to lose a symbol due to deep fades in the case of partially correlated links lies in between, i.e.

$$P_{MISO,uncorrelated} < P_{MISO,partially\ uncorrelated} < P_{MISO,full\ uncorrelated} \tag{2}$$

The following results are obtained with the help of a WiMAX downlink simulator. The data is transmitted in 20 basic allocation units per frame in a PUSC zone. The packet size is 64 Bytes. A tap delay line channel model with six taps is used, each encountering Rayleigh fading, (ITU-R Pedestrian B with 3 km/h). Spatial correlation is included with a correlation matrix per tap [6]. The angular spread is 2° at the BS and 35° at the mobile terminal. The mean angles of departure (AoD) and angles of arrival (AoA) are chosen according to Table 1.

Angles of departure (AOD) and angles of arrival (AOA) used for simulation Table 1

	Tap 1	Tap 2	Tap 3	Tap 4	Tap 5	Tap 6
AoD	18.11°	24.48°	21.11°	6.47°	23.85°	24.24°
AoA	147.34°	50.84°	139.08°	49.5°	260.03°	128.93°

Channel estimation is done with the help of pilots and linear interpolation. Convolutional turbo coding with code rate 1/2 is used. Four turbo decoder iterations are carried out.

We compare cases with no correlation, low correlation (4 λ spacing between the antennas at the BS), high correlation (λ/2 spacing) and full correlation, where λ is the wavelength of the carrier frequency. The results of this study are presented in Fig. 4.

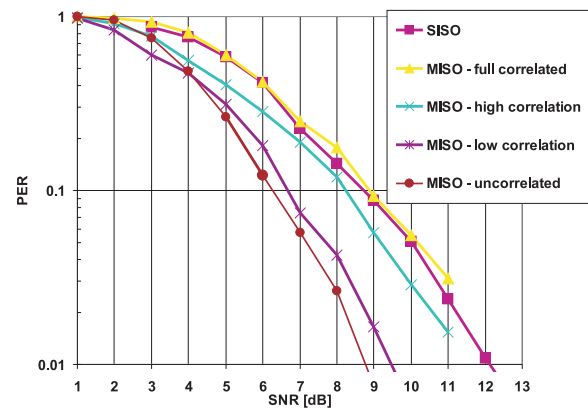

Fig. 4 Impact of correlated links

Obviously, STBC increases the robustness of the link. For all modulation schemes we find a diversity gain of approximately 2.5 dB of STBC compared to SISO at a PER of 10%.

Moreover, we have investigated the impact of correlated links.

As expected, STBC with fully correlated links shows the same behavior as SISO. The lower the correlation, the higher is the performance gain. A spacing of 4λ can be seen as a typical value for the application of MIMO at the BS. Obviously, we achieve almost the same diversity gain as in the case with uncorrelated links.

B. Interference in multi-cell scenarios

Since spectrum is a scarce resource, it is desirable to apply better frequency reuse than RU3 up to RU1 so that each sector uses the same frequency band. However, the frequency reuse capability is limited by the interference from neighboring BSs operating in the same frequency band. It is obvious that in this case the interference increases. Especially at the sector borders the SINR can decrease down to 0 dB or less. In the following text we focus on approaches targeting full RU1 operation enabling the use of the full bandwidth in each sector.

C. System Configurations and Simulation Setup

To assess the potential and the limitations of the different approaches and to evaluate the performance impact on throughput and coverage, simulations with the system level simulation tool according to the principles described in section II.C have been performed. The impact of different parameters like frequency reuse factor, PUSC/AMC permutation and antenna configuration is shown by separate examples for each of the impacts. Table 2 shows the antenna configurations, which are taken into account in the following analysis (only partly for each of the examples). The BF arrays have $\lambda/2$ spacing, the MIMO antennas or MIMO subarrays are separated by 4λ .

The BS distance depends on the selected pathloss model and is between 750 m and 1.2 km. The BSs are located in 30 m height, for the mobile stations 1.5 m are assumed. The “Spatial Channel Model Extended” (SCME) [7] fading channel profile “urban macro” in combination with the Cost-Hata or SUI [8] pathloss model is applied to the reference signal and the interferers. Also 15 dB wall penetration loss for indoor coverage and 8 dB shadow variance is included. The different antenna configurations are modeled with appropriate input parameters and antenna pattern for the SCME model. The total Tx power of 39 dBm is identical for all scenarios. In each interfering sector six users are served, using together all available subchannels. For 300 – 500 Monte Carlo drops of

interfering users the total SINR at each location in the reference sector is calculated with the Exponential Effective SINR Mapping (EESM) method [9].

D. Performance measures

RU 1 operation is only reasonable if sufficient performance can be achieved. The main performance indicators for the assessment of RU 1 approaches are the area coverage and the mean sector throughput. Whereas the minimum required throughput depends on the services to be deployed, the coverage target is usually in the range of 90 – 95% or even higher. The spectral efficiency per sector in bit/s/Hz then is calculated from the total available bandwidth, the mean sector throughput and the complete frame duration.

E. Simulation Results

In a first example the impact of the frequency reuse factor on the spectral efficiency and the coverage is shown. The antenna configurations BF2-STBC, BF2-SM and BF4-MRC are compared, which correspond to 4-antenna BS and 2-antenna MS and the operation modes MIMO+BF with MIMO receiver at the MS or 4-element BF with MRC receiver at the MS. Fig. 5 shows the icdf curves. The curves shifted to the right indicate higher SINR for a larger percentage of the sector area. The PUSC subcarrier allocation with 6 subchannels per interfering user is applied. The dashed lines indicating the RU3 curves are shifted to the right compared to the corresponding RU1 curves, reflecting the higher SINR due to less interference.

In Fig. 6 the corresponding spectral efficiency and the coverage for a minimum data rate of 100 kbit/s is given. The spectral efficiency is for all RU1 configurations higher than for RU3, but the corresponding coverage is only for the MIMO STBC and for the beamforming configuration above 95%. The RU3 configurations reach almost 100% coverage with these configurations. This indicates that the MIMO STBC and the BF schemes mainly contribute to the improvement of coverage and link budget. MIMO SM schemes can significantly improve the peak user throughput, but only in the areas where SM can be applied. The MIMO SM coverage is significantly less than the MIMO STBC or BF coverage.

In another exemplary analysis Fig. 7 and Fig. 8 the impact of the permutation mode is analyzed for MIMO+BF and RU1 operation. Both PUSC and AMC mode are applied with random

Antenna configurations

Table 2

Configu-ration	Number and type of antenna at		Transmission mode	
	Base Station (BS)	Mobile Station (MS)		
SA-SISO	1 sector antenna	1	SISO	Single antenna, pure MIMO
SA-STBC	2 sector antennas	2	MIMO STBC	
SA-SM	2 sector antennas	2	MIMO SM	
BF2-STBC	2 two-element arrays	2	MIMO STBC	2-element BF, MIMO+BF
BF2-SM	2 two-element arrays	2	MIMO SM	
BF4-MRC	1 four-element array	2	MRC	BF

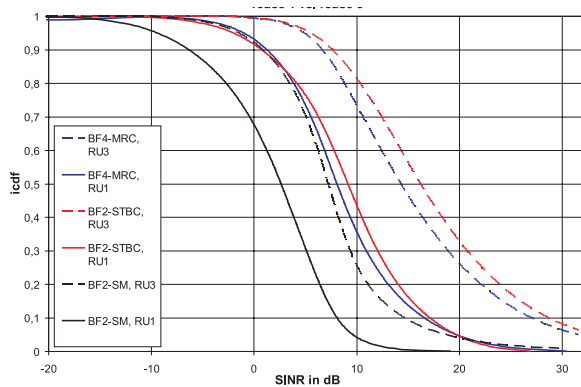

Fig. 5 Comparison of SINR icdf curves of RU 3 (dashed lines) and RU 1 (solid lines) for MIMO+BF and BF antenna configurations and PUSC subcarrier allocation

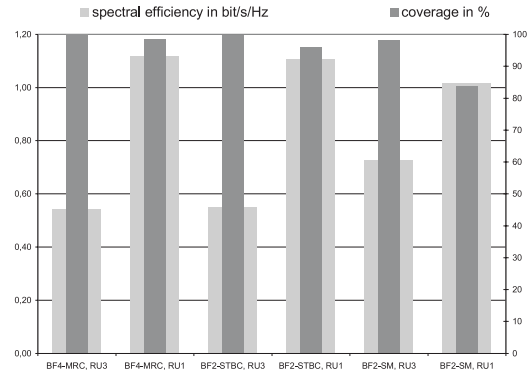

Fig. 6 Spectral efficiency (light grey) and coverage for 100 kbit/s minimum data rate (dark grey) for MIMO+BF and BF antenna configurations with RU3 and RU1

resource allocation to the users. The curves for AMC permutation (solid lines) are shifted to the right part of the diagram, indicating higher throughput at SINR values between 10 and 20 dB. Here

the higher order modulation schemes can be applied for more points, thus increasing the mean sector throughput. This can be seen also in Fig. 8, where the AMC subcarrier allocation shows for each

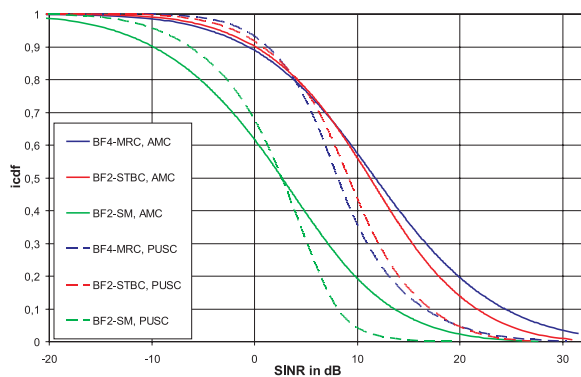

Fig. 7 Comparison of SINR icdf for PUSC and AMC MIMO+BF and BF configurations

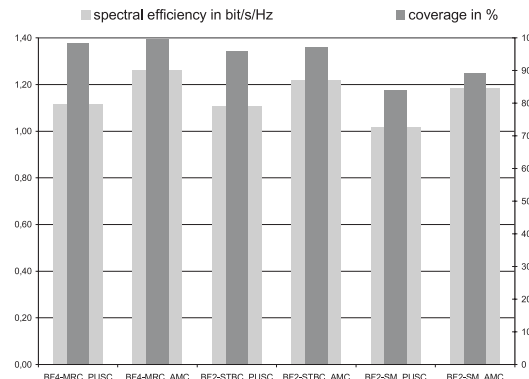

Fig. 8 Spectral efficiency and coverage for PUSC and AMC MIMO+BF and BF configurations

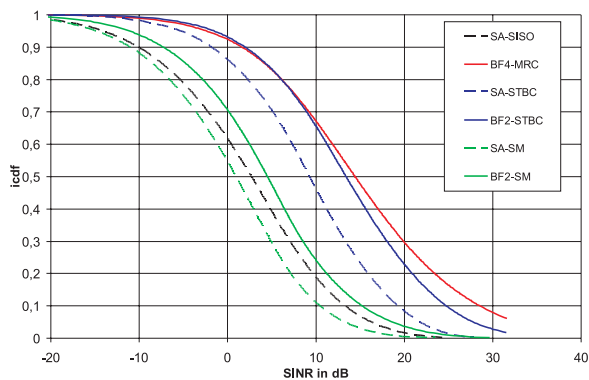

Fig. 9 Comparison of SINR icdf curves for single antenna and multi-antenna MIMO and BF configurations

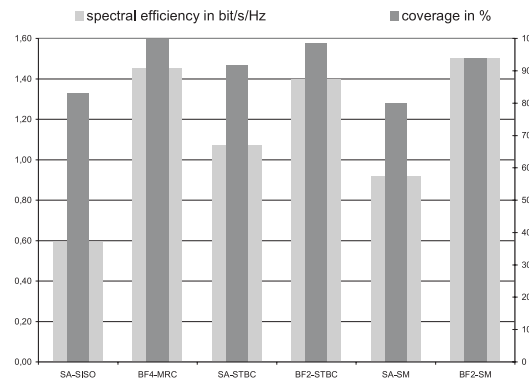

Fig. 10 Comparison of spectral efficiency and coverage for single antenna and multi-antenna MIMO and BF configurations

antenna configuration an increased spectral efficiency and a slightly increased coverage compared to PUSC.

In a further example Fig. 9 the relation between fixed sector antenna MIMO (dashed lines), MIMO+BF and BF (solid lines) is shown. The results are for AMC in combination with the SUI pathloss model and urban macro profile of the SCME fading channel. In Fig. 9 it can be seen that MIMO+BF with STBC and BF with 4 elements have almost identical performance, whereas the curve of the fixed sector antenna MIMO is shifted about 5 dB to the left. MIMO SM with fixed antennas is even worse than SISO, whereas MIMO+BF SM is about 1 dB better than SISO. The corresponding spectral efficiency and coverage are given in Fig. 10. Whereas the coverage of the fixed antenna configurations is only up to 50% - 75%, the multi-antenna configurations MIMO+BF STBC and BF reach up to nearly 90% coverage in this scenario at almost identical spectral efficiency. This clearly indicates that WiMAX systems for RU1 operation with reasonable coverage need to exploit the interference mitigating properties of adaptive multiple antenna solutions, either with BF or with the combination of MIMO and BF.

4. Uplink system model

In the current WiMAX 802.16e standard, the mobile terminal deploys one antenna for uplink signal transmission. The BS has a degree of freedom to utilize diverse antenna configurations with 2 or 4 receive antennas. The beamforming technique is one of the key strategies to combine the useful signal and meanwhile suppress the interference. Throughout this section, the Spatial Maximum Ratio Combining (S-MRC) and the Spatial Minimum Mean Square Error (S-MMSE) beamformers are focused on. Let us firstly consider the narrowband signal model by the system equation,

$$y = hs + n, \quad (3)$$

where s is the transmit signal with instantaneous energy per symbol E_s . The denotations y , h and n stand for complex $N \times 1$ vectors for receive signals with N BS antennas, frequency flat channel coefficients and spatially white Gaussian noise samples with variance $\sigma^2/2$ per dimension. The S-MRC takes the Hermitian of channel estimates as the beamforming weights, i.e.

$$w_{S-MRC} = \frac{h^H}{\|h\|^2} \quad (4)$$

by assuming perfect channel information at the receiver. The operator $\|\cdot\|$ denotes the norm of a vector. The signal combining can be straightforwardly done as

$$\hat{s} = w_{S-MRC} \cdot y = \frac{h^H}{\|h\|^2} (hs + n) = s + \frac{h^H}{\|h\|^2} n. \quad (5)$$

Hence, the SNR can be computed by

$$SNR_{S-MRC} = \frac{E[s \cdot s^*]}{E\left[\frac{h^H}{\|h\|^2} n \cdot \left(\frac{h^H}{\|h\|^2} n\right)^*\right]} = \frac{E_s}{E\left[\frac{h^H (\sigma^2 I) h}{\|h\|^4}\right]} = \frac{E_s}{\sigma^2 E\left[\frac{h^H h}{\|h\|^4}\right]} = E[\|h\|^2] \frac{E_s}{\sigma^2}. \quad (6)$$

In the case that co-channel interference is present, the system equation (3) becomes

$$y = hs + \sum_{i=1}^{M-1} h_i s_i + n, \quad (7)$$

where s_i is the signal from the i^{th} interferer, and h_i denotes the corresponding channel vector. The number of interferers is given by $M - 1$. With the ideal S-MRC beamforming weights in (4), the SINR is consequently

$$SINR_{S-MRC} = E[\|h\|^2] \frac{E_s}{\sum_{i=1}^{M-1} E\left[\frac{\|h^H h_i\|^2}{\|h\|^4}\right] E_s + \sigma^2}. \quad (8)$$

In (8), it is shown that the S-MRC beamformer does not consider the interference when calculating the weights w_{S-MRC} . On the other hand, if the channels h and h_i are spatially independent and identical distributed random variables, the S-MRC beamformer yields the array gain $E[\|h\|^2]$ with diversity order N . Nevertheless, the prerequisite above is sometimes hardly to be satisfied, especially with $\lambda/2$ spacing. The S-MRC thus suffers from the interference to a certain degree.

It is well known that the MMSE criterion is linearly optimal in a statistical sense [10]. To investigate the S-MMSE beamformer, equation (7) has to be reformulated in a matrix expression as

$$y = Hs + n, \quad (9)$$

where H is an $N \times M$ channel matrix, and it holds $H = [h \ h_1 \ h_2 \ \dots \ h_{M-1}]$. The signal s is a $M \times 1$ vector, and it holds $s = [s \ s_1 \ s_2 \ \dots \ s_{M-1}]^T$. Without loss of generality, both the user of interest and the interferers are assumed to have the same transmit signal energy per symbol E_s . The S-MMSE beamforming weights can be presented in a general form as

$$w_{S-MMSE} = E_s h^H (E[yy^H])^{-1} = E_s h^H R_{yy}^{-1}, \quad (10)$$

with the covariance matrix R_{yy} of the received signal vector y . The SINR with respect to the signal s of the user of interest is according to [11]

$$SINR_{S-MMSE} = \frac{\det(R_{yy})}{\det(R_{yy} - E_s h h^H)} - 1. \quad (11)$$

In chapter V, it will be shown that the S-MMSE beamformer outperforms S-MRC at low SINR. At high SINR, the S-MRC beamformer converges the performance of S-MMSE with diversity order N .

In the link level simulator, pilot based channel estimation is applied. The channel estimates for uplink user m is given by

$$\hat{\mathbf{h}}^{(m)} = [\hat{h}^{(l,m)} \dots \hat{h}^{(n,m)} \dots \hat{h}^{(N,m)}]^T. \quad (12)$$

In the expression form of $\hat{h}^{(i,j)}$, i denotes the receive antenna index, and j denotes the uplink user index. The S-MRC weights can be thus straightforwardly obtained with (4) as

$$\mathbf{w}_{S-MRC}^{(m)} = \frac{[\hat{\mathbf{h}}^{(m)}]^H}{\|\hat{\mathbf{h}}^{(m)}\|^2}. \quad (13)$$

For S-MMSE beamformer, the covariance matrix is computed on the basis of the pilot grid. It yields

$$\hat{\mathbf{R}}_{yy} = \frac{1}{M} \sum_m \hat{\mathbf{h}}^{(m)} [\hat{\mathbf{h}}^{(m)}]^H. \quad (14)$$

In order to increase the robustness of the S-MMSE beamformer, for the matrix inversion a diagonal loading factor D is introduced. This methodology in array processing theory [12] is called Loaded Sample Matrix Inverse (LSMI) beamforming. The LSMI weights for uplink user are given by

$$[\mathbf{w}_{SMI}^{(m)}]^T = [\hat{\mathbf{h}}^{(m)}]^H [\hat{\mathbf{R}}_{yy} + D \cdot \text{tr}(\hat{\mathbf{R}}_{yy}) \cdot \mathbf{I}]^{-1}. \quad (15)$$

Finally, the corresponding S-MMSE beamforming weights become

$$\mathbf{w}_{S-MMSE}^{(m)} = \frac{\mathbf{w}_{SMI}^{(m)}}{\|\mathbf{w}_{SMI}^{(m)}\|} \|E[\hat{\mathbf{h}}^{(m)}]\|. \quad (16)$$

5. Uplink performance comparison

In this section, the S-MRC and S-MMSE beamformers are investigated and compared with link level simulations. Firstly, the resulting beam patterns for both methods are presented in Fig. 11. We assume that the BS has 4 receive antennas with $\lambda/2$ spacing between the elements, and both user - and interferer terminal is equipped with one transmit antenna. The spatial separation of user and interferer is 10° .

In Fig. 11(b), it can be observed that the S-MRC beamformer is able to combine the antenna signals exactly in the direction of the user of interest, without considering the direction of the inter-

ferer. The disadvantage of S-MRC was already mentioned during the discussion of (8). If the radio channels of interferer and user are spatially independent and identical distributed, not so much performance degradation is introduced by the interferer. Nevertheless, as a matter of fact, 10° spatial separation does not statistically allow enormous independency. Hence, the interference term in the denominator in (8) cannot be neglected, which finally decreases the SINR. In contrast, the MMSE criterion tries to linearly optimize the SINR, which is shown in Fig. 11(a). The S-MMSE beamformer does not place its main beam to the direction of the user of interest. Instead, it rotates the main beam direction such that the interferer is possibly placed in the direction around a null position, and the user of interest is placed in the direction exhibiting satisfactory array gain.

In Fig. 12, the S-MMSE beam patterns are presented for one user of interest and two interferers. The beamformer has in this situation lower degree of freedom compared to the case with only one interferer in Fig. 11. Nevertheless, the MMSE algorithm establishes an optimal beam to possibly suppress both interferers.

Link level simulations for the S-MRC and S-MMSE beamformers were carried out for AMC mode. The simulation parameters are given in Table 3. The simulations focus on the scenario for one user of interest and one interferer with spatial separations 10° and 20° . As fading channel model, ITU-R Pedestrian B with 3 km/h was used. Fig. 13 and Fig. 14 show the coded PER and data throughput for the case with 10° spatial separation between user of interest and interferer. Fig. 13 shows that S-MMSE outperforms its counterpart at low SINR, and S-MRC is able to suppress the interferer to a certain degree at high SINR. The relative beamforming gain of S-MMSE over S-MRC ranges from 0.8 dB to 2.3 dB with respect to 10 % PER, depending on the modulation scheme.

Fig. 14 illustrates the throughput benefit from another aspect. By observing the SINR at 10% PER of the S-MMSE beamformer, e.g. approximately 7.5 dB for 64QAM, the throughput benefit of S-MMSE over S-MRC is roughly 330 kbps/subchannel. The throughput benefit of the S-MMSE with other modulation schemes can be similarly observed (16QAM: 330 kbps/subchannel; QPSK: 200 kbps/subchannel).

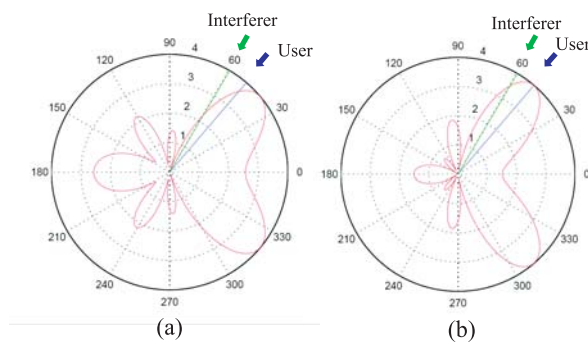

Fig. 11 S-MMSE (a) and S-MRC (b) beamformer pattern

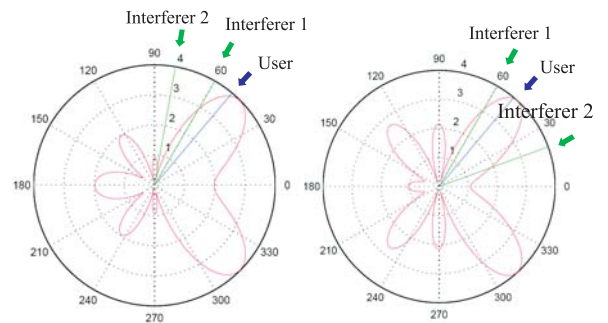

Fig. 12 S-MMSE beam patterns with two interferers

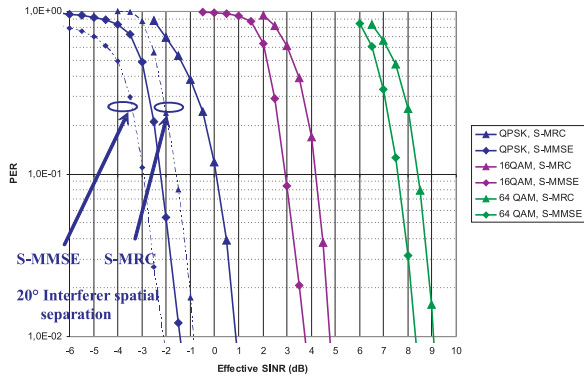

Fig. 13 PER curves with 10° spatial separation

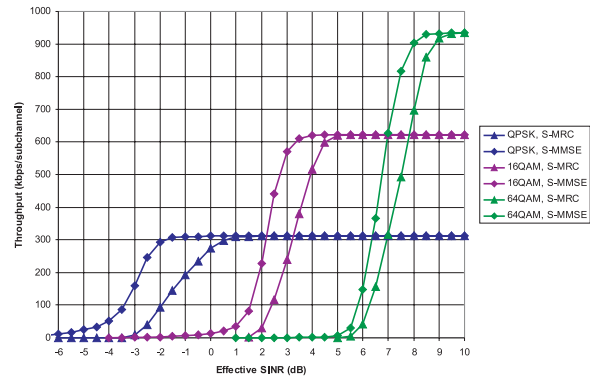

Fig. 14 Throughput curves with 10° spatial separation

Simulation parameters

Table 3

Remarks	Parameters
Number of antenna elements	4
Antenna spacing	0.5 λ
Beamforming method	S-MMSE and S-MRC
FEC coding rate	1/2
FEC option	Convolutional Turbo Code (CTC)
Modulation option	QPSK, 16QAM, 64QAM
FFT size	1024
OFDM permutation mode	AMC 2x3
Packet size for the single user inside of one OFDM uplink frame	60 Bytes (QPSK, 16QAM), 54 Bytes (64QAM)
Interferer separation spacing	10° or 20°
Switch to enable or disable the sounding	Enable
Subchannel rotation	OFF
Channel	Pedestrian B 3 km/h (PedB3)

In Fig. 13 the interference suppression capability is additionally presented for S-MMSE and S-MRC with 20° interferer spatial separation. The absolute performance is better and the relative performance gap between S-MMSE and S-MRC decreases. The behavior is already indicated in the section IV, that the S-MRC approaches S-MMSE performance due to insignificant spatial correlation between the fading channels of the user and that of the interferer.

6. Conclusion

We have discussed various applications of multiple antenna configurations in both uplink and downlink for the mobile broadband wireless access system WiMAX, which is based on the current

IEEE 802.16e standard. Firstly, it was shown that the exploitation of diversity in partly decorrelated channels improves the link level performance using 2x1 MISO STBC mode.

However, on system level additional criteria for the correct selection of the appropriate operation mode can be derived. Downlink beamforming as well as MIMO STBC improve the robustness of a link, whereas MIMO SM targets a high spectral efficiency. The latter requires uncorrelated MIMO channels and a high SINR, which limits the application basically in dense urban environments near to the BS. The combination of MIMO and beamforming allows for a further decorrelation of the MIMO channels and thus enlarges the application area of MIMO SM.

Finally two uplink receive beamforming algorithms, namely S-MRC and S-MMSE were presented and compared. S-MRC requires uncorrelated channels between user of interest and interferer to exploit a diversity gain. The beam pattern is directed to the user of interest without consideration of the interferers. S-MMSE explicitly optimizes the resulting SINR by selecting the beamforming weights such that the interferers are located closely to nulls of the beam pattern. It was shown that S-MMSE is superior to its counterpart.

Generally, future broadband wireless access systems, e.g. 802.16 m, have to fall back on diverse options for multiple antenna systems to fulfill their manifold performance requirements. Multiple antenna systems can therefore be seen as one basic building block for future wireless communications.

Acknowledgment

This work has been supported by the German Ministry for Education and Research (BMBF) within the EUREKA MEDEA+ project MIMOWA, which is kindly acknowledged.

References

- [1] IEEE 802.16Rev2/D3: *Air Interface for Broadband Wireless Access Systems*, February 2008.
- [2] WiMAX Forum Mobile System Profile Release 1.0, Revision 1.6.1, 2008.

- [3] ALAMOUTI, S. M.: *A Simple Transmit Diversity Technique for Wireless Communications*, IEEE Journal on Selected Areas in Communications, 8/1998, pp. 1451-1458.
- [4] KANG, H.G., PARK, J., AN, T., OH, J., SONG, I.: *An ML Decoding Algorithm with Reduced Complexity for Multi-Input Multi-Output Systems*, Intern. Symposium on Signals, Systems and Electronics ISSSE '07, 2007, pp. 339-342.
- [5] YOO, B., LEE, K. H., LEE, C.: *Implementation of IEEE 802.16e MIMO-OFDMA Systems with K-BEST Lattice Decoding Algorithm*, Intern. Conference on Consumer Electronics ICCE 2007, Digest of Technical Papers, 2007, pp. 1-2.
- [6] IEEE 802.16m Evaluation Methodology Document (EMD), 2008.
- [7] 3GPP Technical Report 25.996: *Spatial channel model for Multiple Input Multiple Output (MIMO) simulations*, V6.1.0, 2003.
- [8] ERCEG, V. et al., *Channel Models for Fixed Wireless Applications*, IEEE 802.16.3c-01/29r5, June, 2003.
- [9] TSAI, S., SOONG, A.: *Effective SNR mapping for modelling frame error rates in multiple-state channels*, 3GPP2-C30-20030429-010, April 2003.
- [10] HAYKIN, S.: *Adaptive Filter Theory*, Prentice Hall, 1996.
- [11] PAULRAJ, A., NABAR, R., GORE, D.: *Introduction to Space-Time Wireless Communications*, Cambridge, 2003.
- [12] VAN TREES, H. L.: *Optimum Array Processing, Part IV of Detection, Estimation, and Modulation Theory*, John Wiley & Sons, 2002.

J. S. Vardakas – V. G. Vassilakis – M. D. Logothetis *

PERFORMANCE MODELLING AND ANALYSIS OF PASSIVE OPTICAL NETWORKS FOR POISSON TRAFFIC

Passive Optical Networks (PONs) are the most important class of fiber-based access systems, capable of delivering services with numerous applications, such as high-definition video and video conferencing. In this paper we perform call-level performance analysis of the upstream direction in TDMA-based PONs and hybrid TDMA-WDM PONs. The proposed analysis is based on well-established recursive teletraffic models and leads to Call Blocking Probabilities determination. We consider the case where the optical access network accommodates multiple service-classes with Poisson arriving calls. The accuracy of the proposed analytical models is validated by simulation and is found to be absolutely satisfactory.

1. Introduction

The information and application explosion that we are currently experiencing have forced the research community to the development of optical access networks, since advantages in the optical technology significantly reduced the cost of introducing fiber to the local loop. An access network is generally known as the “first mile” network that connects service providers with small businesses and residential users. The users of access networks demand a cost-effective access at high data rates and with Quality of Service (QoS) guarantees. Similarly, businesses request a broadband infrastructure, where their local networks can be efficiently connected to the Internet. In addition, service providers wish for the development of reliable and scalable access solutions with the perspective of adjusting to future applications and to the growing bandwidth needs.

Over the past several years telecom industries focused on the development of high capacity backbone networks. In contrast, existent access solutions, such as Digital Subscriber Line (DSL), provide relatively low data rates at the downstream channel (a few Mbps) and at the upstream channel (a few hundreds of Kbps) [1]. Therefore, access networks are considered as the basic drawback for providing broadband services, such as video on-demand, interactive games, video conference, etc.

Currently, the dominant broadband access solutions are DSL and Community Antenna Television (CATV). These technologies report several disadvantages, since they are based on infrastructures, originally developed for carrying voice traffic only. In DSL, an important constraint is the distance between end users and service providers, which cannot exceed 6 Km, due to the signal attenuation [1]. Therefore only 60% of residential subscribers may access the Internet through a DSL [2]. Recently, variations of DSL

are introduced, such as Very high bit-rate DSL (VDSL) which can support up to 50 Mbps of downstream bandwidth, but with more severe distance limitations (~ 500 m). On the other hand, CATV networks can offer Internet access by reserving Radio Frequency (RF) channels in coaxial cables. Since cable networks were originally built for delivering broadcast services, they have a poor performance when they provide access bandwidth.

The abovementioned problems of the existent access networks can be confronted with the introduction of optical technology, given that optical fibers provide huge capacity with very low losses. Optical access networks can support data rates of several Gbps, while their cost is similar to that of DSL [3]. Since optical fibers can support any kind of traffic format, the installation of optical fibers to access networks is an investment, providing insurance for supporting future applications. Moreover, the installation of optical fibers must meet economic parameters, since in many cases service providers wish to maintain their investments in the existent infrastructure. 85% of the total cost of a new optical access network refers to civil works, while only 3% refer to the equipment cost [4]. Therefore, in cases of installing a new network, the optical fiber is installed up to the subscriber’s location (Fiber-To-The-Home, FTTH), or if it is desirable to maintain parts of the existing network, fibers are installed up to the curb (Fiber-To-The-Curb, FTTC), or up to the building (Fiber-To-The-Building, FTTB) [4].

Different fiber-based access architectures have been proposed (or even deployed in some countries) [4]. The implementation of point-to-point access architectures by using dedicated fibers to each subscriber offers huge bandwidth to the subscriber; however, the cost of the users’ equipment is high, since a pair of transmitters has to be installed for each point-to-point connection. An alternate solution that offers shared access refers to the installation of an active node in the users’ premises. This approach reduces

* J. S. Vardakas, V. G. Vassilakis, M. D. Logothetis

Wire Communications Laboratory, Department of Electrical & Computer Engineering, University of Patras, Greece.

Email: jvardakas@wcl.ee.upatras.gr

the users' equipment cost, but maintenance and power supply to the active node is required. Another shared access architecture is the Passive Optical Network (PON), where the active node is replaced with a passive device. PONs have several advantages over active node architectures. PONs incur lower capital expenditures, since no electronic components are used. The overall cost is further decreased by the absence of power supplying and maintenance of the passive node [5]. Moreover, PONs are transparent: the upgrade to higher bit rates and the support of new applications are simpler for a PON than for an active node architecture.

A PON consists of an Optical Line Terminal (OLT), located at the central office and optical nodes which are located in the subscribers' premises and are called Optical Network Units (ONUs) [6]. All ONUs are connected to the OLT through a passive combiner/splitter (Fig. 1). The communication between the ONUs is realized only through the OLT. Signals from the ONUs are combined in the passive element and are transmitted to the OLT through a single fiber; signals from the OLT are separated in the passive element and are then sent to ONUs. In other words, in the downstream direction (from the OLT to the ONUs) traffic is sent from one point to multiple points, while in the upstream direction (from the ONUs to the OLT), traffic from multiple points, reaches only one point.

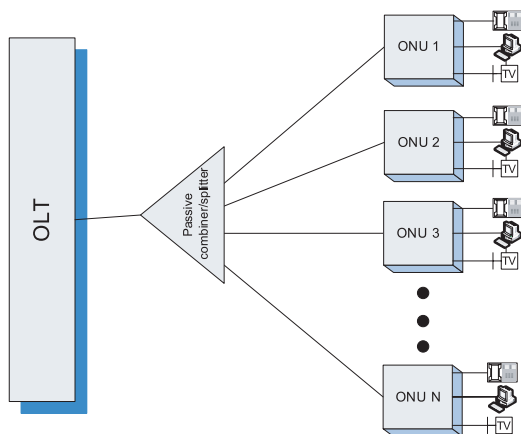

Fig. 1 A typical PON infrastructure

PONs come in different flavors, depending on the multiple access schemes they deploy. TDMA PONs are already standardized and not only are commercially available but also have been deployed in some countries. The APON, i.e. Asynchronous Transfer Mode PON and the Broadband PON (BPON) have been standardized by the International Telecommunications Union - Telecommunication Standardization Sector (ITU-T) (G.983). Likewise, the Gigabit PON (GPON); and the Ethernet PON (EPON) have been standardized by the ITU-T G.984 and IEEE 802.3ah, respectively. Nowadays, although the TDMA-based PON configurations are the most popular configurations for providing Fiber-To-The-Home/Fiber-To-The-Premises (FTTH/FTTP) services, a number of next-generation PON architectures are being studied too, in

order to satisfy future bandwidth needs. Dynamic bandwidth allocation is an effective solution for improving the bandwidth utilization in the network. Another solution is the implementation of the Wavelength Division Multiplexing (WDM) technology in the PONs. Therefore, PONs based on TDMA can be upgraded, wherein multiple channels can be used both in the upstream and the downstream directions, resulting in TDMA-WDM PONs. The next generation of PONs are the key elements for satisfying the future high bandwidth demands coming from the steadily increasing number of users and from the emerging bandwidth intensive services [7].

In this paper we present a call-level analysis of TDMA PONs and hybrid TDMA-WDM PON configurations for the upstream direction, with dynamic bandwidth allocation. The presented analysis is based on well-established teletraffic models [8], [9], [10]. We calculate Call Blocking Probabilities (CBP) that occur due to the restricted bandwidth of a wavelength. We consider that calls belong to different service-classes with Poisson arrival process. We also study the case where the traffic overflowing the capacity of the primary wavelength is offered to a secondary wavelength.

The rest of this paper is organized as follows. Section 2 provides an overview of the TDMA PONs and the WDM PONs. Section 3 presents the analytical models for calculating the CBP in the aforementioned PON configurations. In section 4 we provide analytical and simulation results of the presented models. We conclude in Section 5.

2. Multiple Access Techniques in Passive Optical Networks

2.1 TDMA Passive Optical Networks

Current PON configurations are based on Time Division Multiplexing (TDM) technology. The benefits of implementing TDM in PONs are several, such as the low cost of the users' equipment (simple optical transceivers that are tuned to a single frequency) and the flexibility concerning the addition of new users. The first generation of PONs has been standardized by ITU-T G.983 and uses Asynchronous Transfer Mode (ATM) as the Medium Access Control (MAC) protocol. The capacity of the upstream direction is 155.52 Mbps, while the capacity of the downstream direction is 155.52 or 622.08 Mbps [11]. The upstream channel operates at 1.3 μm , whereas the downstream channel operates at 1.5 μm . The maximum splitting ratio (i.e. the maximum number of ONUs that the network can support) is 32 or 64 and the maximum distance between the OLT and the ONUs is 20 Km. A standard single-mode fiber is used in all links i.e., for the connection between the OLT and the passive device and for the connections between the passive device and the ONUs. For the upgrade of the APON, a newer version of the original G.983.1 standard published in 2005 [12] added 1244.16 Mbps downstream transmission rate and 622.08 Mbps upstream transmission rate. Because the term APON gave the impression that only ATM-based services can be supported, ITU-T introduced the term BPON, since these networks can support video and Ethernet traffic.

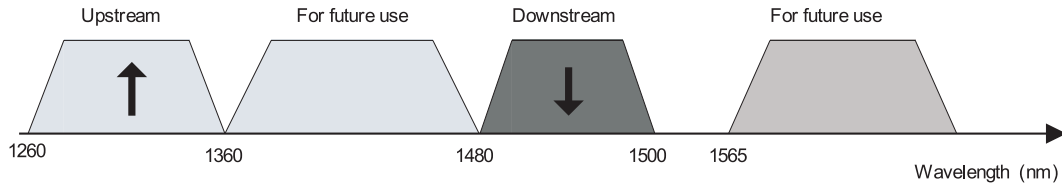

Fig. 2 Wavelength allocation plan in ITU-T G.983.3

The extension of the capacity of PONs to the Gbps arena is realized with the introduction of the G.984.x standard series for the GPON. The GPON architecture is similar to the APON/BPON architecture, whereas the maximum splitting ratio is 128 and the distance between the OLT and the ONUs is up to 30 Km. The GPON supports downstream data rates of 1244.16 or 2488.32 Mbps in the wavelength range 1480–1500 nm, while in the upstream direction the GPON supports 155.52, 622.08, 1244.16, or 2488.32 Mbit/s data rates, in the wavelength range 1260–1360 nm [4].

In these TDMA PONs the bandwidth either in the upstream or the downstream direction is allocated by the OLT to the ONUs, based on their bandwidth requests and their Service Level Agreements (SLA). Generally, two are the main algorithms that are used for bandwidth allocation; the Static Bandwidth Allocation (SBA) and the Dynamic Bandwidth Allocation (DBA). Since SBA distributes a fixed bandwidth to each ONU resulting in low utilization of the network’s capacity, DBA is an efficient method for a flexible bandwidth allocation and for eliminating idle periods.

Although TDMA PONs provide significant bandwidth boost as compared to copper-based access networks, their capacity will be exhausted as bandwidth-hungry applications such as High Definition TV (HDTV) and video conferencing become available. An upgrading approach for the TDMA-PONs is to combine the TDMA technology together with the WDM technology. In the resulting hybrid TDMA-WDM PON, multiple wavelengths are used in upstream and downstream directions, so that the access network becomes flexible and efficient in providing the required bandwidth to the users [13]. In early TDMA-WDM PONs systems, each ONU uses expensive optical transmitters, generating a unique wavelength. Cost-effective approaches [6], [14] make TDMA-WDM PONs the ideal solution for broadband access networks.

2.2 TDMA-WDM Passive Optical Networks

PONs based on TDMA can be upgraded, wherein multiple channels can be used both in the upstream and the downstream directions. The implementation of WDM technology in PONs stumbled at the high cost of the transceivers, which must be tuned in any of the supported wavelengths. New advantages in the area of optical modulation brought forward the idea of using WDM in order to increase the bandwidth capacity. To exploit the vast bandwidth in the optical fiber and make the value out of the capital-intensive fiber plants, ITU-T specified Coarse WDM (CWDM) overlay on the original PON infrastructures [15]. Fig. 2 illustrates

the wavelength grid, specified in ITU-T G.983.3. The two bands that are reserved for future use 1) 1360–1480 nm and 2) 1565 nm and beyond, may be used by existing fiber plants for supporting new services or overflow traffic.

Another way to increase PON-system scalability is to use Dense WDM (DWDM) [16]. The passive optical splitter/combiner is replaced by an Arrayed Waveguide Grating (AWG) router. Each transmitter-receiver pair (located at the OLT and an ONU or vice versa) is set at a specific wavelength band of a port of the AWG, to which the pair is connected. In this way a single wavelength may be used for the connection of an ONU with the OLT, for the upstream and/or the downstream direction, offering excellent privacy to each ONU. Fig. 3 illustrates a simple WDM PON configuration, where the wavelengths λ_1 and λ_2 are used in the upstream direction, while the wavelengths λ_3 and λ_4 are used in the downstream direction. Moreover, WDM-PONs provide easy pay-as-you-grow upgrade, since each wavelength may run at different speed, while each subscriber’s services can be configured and changed independently from the services of other subscribers.

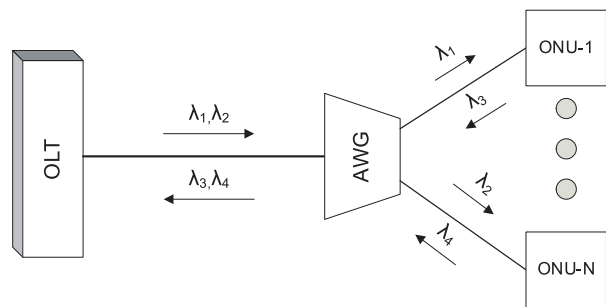

Fig. 3 A typical WDM-PON configuration

For the upgrade of an existing TDMA PON to a hybrid TDMA-WDM PON the fiber plant remains unchanged, while modifications on the ONU’s equipment are necessary, in order for each ONU to connect to the OLT using a single wavelength. To make ONUs operational in a WDM PON, they need to be identical, yet capable of functioning according to the wavelength plan. Such ONUs are called “colorless ONUs”. The installation of colorless ONUs increases the overall cost, complicates maintenance and decreases the user friendliness. Alternatively, several approaches may be used [17], [18] which can benefit of economy of scale, and thus lower costs.

3. Call-level performance analysis of PONs

3.1 TDMA PON case

We consider a TDMA PON (with the configuration illustrated in Fig. 1) with N ONUs. Let T bandwidth units (b.u.) be the capacity of the optical fiber that connects the passive element to the OLT. Calls arrive to each ONU according to a Poisson process and are groomed onto the optical fiber. Each ONU accommodates K service-classes. Each service-class k ($k = 1, \dots, K$) call requires b_k b.u. from the OLT, in order to be serviced (fixed bandwidth requirement). The arrival rate of service-class k calls is denoted by λ_k , while their service times are exponentially distributed with mean μ_k^{-1} . Considering that the total offered traffic-load of service-class k is $a_k = N \cdot \lambda_k \mu_k^{-1}$, the occupancy distribution $q(i)$ of the optical fiber is given by the following recurrent formula (Kaufman/Roberts recursion, [8], [9]):

$$iq(i) = \sum_{k=1}^K a_k b_k q(i - b_k) \quad \text{for } i = 1, \dots, T \quad (1)$$

with $q(i) = 0$ for $i < 0$ and $\sum_{i=0}^T q(i) = 1$.

The CBP of service-class k calls can be calculated given that the blocking states for a service-class k call are the last b_k states (states with occupancies greater than $T - b_k$). Therefore:

$$B_k = \sum_{i=T-b_k+1}^T q(i) \quad (2)$$

Let us consider that the aforementioned PON configuration can additionally support one of the two bands available for the future use that are indicated in Fig. 2. This wavelength band corresponds to a secondary capacity (denoted by T_2), and calls that are lost in the primary wavelength band (with capacity denoted by T_1) are offered to this secondary wavelength. In order to calculate the traffic loss in this hierarchical network, we follow the analysis of [10], where the Multiservice Overflow Approximation (MOA) method is proposed. The traffic load of service-class k offered to the primary capacity is denoted by a_k^0 and the bandwidth requirement of a service-class k call is denoted by b_k . The offered overflow traffic of service-class k is described by its mean value, denoted by a_k^1 and its peakedness, denoted by z_k^1 .

The MOA method includes three steps. In the first step we calculate the blocking probabilities of service-class k , denoted by B_k^0 using (2). In the second step we calculate the mean and the peakedness of the service-class k overflow traffic from the primary to the secondary wavelength. The mean of the overflow traffic is given by the average traffic loss in the primary capacity, therefore:

$$a_k^1 = a_k^0 \cdot B_k^0 \quad (3)$$

For the calculation of the peakedness of the overflow traffic from the primary wavelength, we map this primary capacity into an "imaginary" overflow model, where the traffic streams which

are originally offered the primary capacity are assumed to direct to K "imaginary" bandwidth groups, classified by service-classes. We denote by β_k^0 the number of "imaginary" bandwidth groups for service-class k . The bandwidth requirement of each service-class k call in the "imaginary" bandwidth groups is assumed to be $d_k^* = 1$. In order to calculate β_k^0 , we use the function

$$E(\beta_k^0, a_k^0) = B_k^0 \quad (4)$$

where $E()$ denotes the loss probability of the Erlang loss function. The peakedness z_k^* of service-class k overflow traffic from the "imaginary" bandwidth groups β_k^0 can be calculated by Riordan's equation [10]:

$$z_k^* = 1 - a_k^* + \frac{a_k^0}{1 + \beta_k^0 - a_k^0 + a_k^*} \quad (5)$$

where a_k^* is the mean of service-class k overflow traffic from the "imaginary" β_k^0 bandwidth groups. Finally, in the third step we obtain the characteristics of the service-class k overflow traffic from the primary wavelength, whereas the mean traffic is given by (3) and the peakedness is given by:

$$z_k^1 = z_k^* \cdot z_k^0 = z_k^* \quad (6)$$

since $z_k^0 = 1$ is the peakedness of the Poisson traffic originally offered to the primary wavelength. The CBP of service-class k , denoted by B_k^1 , can be calculated by a modification of the Fredericks & Hayward's approximation method [10], by using (1) and (2), where the capacity T is equal to T_2/z_k^1 and the service-class k offered traffic load a_k is equal to a_k^1/z_k^1 .

3.2 TDMA-WDM PON case

The aforementioned analysis can be extended in order to provide the CBP in a TDMA-WDM PON. Since each one of the N ONUs utilizes a different wavelength, the distribution of the occupied b.u. inside the wavelength n ($n = 1, \dots, N$) is given by:

$$iq_n(i) = \sum_{k=1}^{K_n} a_{k,n} b_{k,n} q(i - b_{k,n}) \quad \text{for } i = 1, \dots, T \quad (7)$$

with $q_n(i) = 0$ for $i < 0$ and $\sum_{i=0}^{T_n} q_n(i) = 1$.

where the n^{th} ONU utilizes a wavelength with bandwidth capacity T_n and supports K_n service classes, while $a_{k,n}$ is the offered traffic-load and $b_{k,n}$ is the bandwidth requirement of service-class k_n ($k_n = 1, \dots, K_n$) calls. The CBP of service-class k_n calls can be calculated by

$$B_{k,n} = \sum_{i=T_n-b_{k,n}+1}^{T_n} q_n(i) \quad (8)$$

It is evident that the MOA method can be used for the case that the PON supports additional wavelengths for carrying the overflow traffic from the primary wavelengths.

4. Numerical Results

In this section we provide analytical and simulation CBP results for the two PON configurations presented in this work, by providing two examples. In the first example we consider a TDMA PON with capacity T , while the number of ONUs is 32. The TDMA PON accommodates a data service and a video service with bandwidth requirements 20 b.u. and 6 b.u., respectively. We assume that 1 b.u. corresponds to 1 Mbps, therefore the capacity T is 155, 622, 1244 or 2048, following the upstream data rates of the TDMA PONs. We assume that both service-classes offer the same amount of traffic, therefore $a_1 = a_2 = a$. Fig. 4(a)-(d) provide analytical and simulation CBP results versus the traffic-load that is offered by each ONU. The comparison of the analytical and the corresponding simulation results show a completely satisfactory accuracy of the proposed model. The study of these figures reveals the maximum offered traffic-load that each PON configuration can support, for specific values of blocking. In the second example we consider that calls that are lost in the primary capacity are offered to a secondary wavelength with the same capacity T . Fig. 5 (a)-(d) illustrate the analytical and simulation CBP results in the secondary wavelength versus the traffic-load a that is offered by each ONU.

All results show that the model's accuracy is completely satisfactory.

5. Conclusion

In conclusion, we present a call-level performance analysis of different PON configurations, for Poisson traffic. We study the upstream direction of TDMA PONs and TDMA-WDM PONs. The models are evaluated through extensive simulation in respect of their results. The accuracy of the models was found to be absolutely satisfactory. The presented models may help network operators to obtain full knowledge of the network's behaviour under extremely high traffic-loads. Moreover, these models may provide useful information to service providers before installing a new PON, by indicating the network parameters for optimum performance. Therefore in our future work we shall continue to study the performance of PONs, by taking into account finite number of traffic sources, while we will include in our study not only the upstream but also the downstream direction (from OLT to the ONUs).

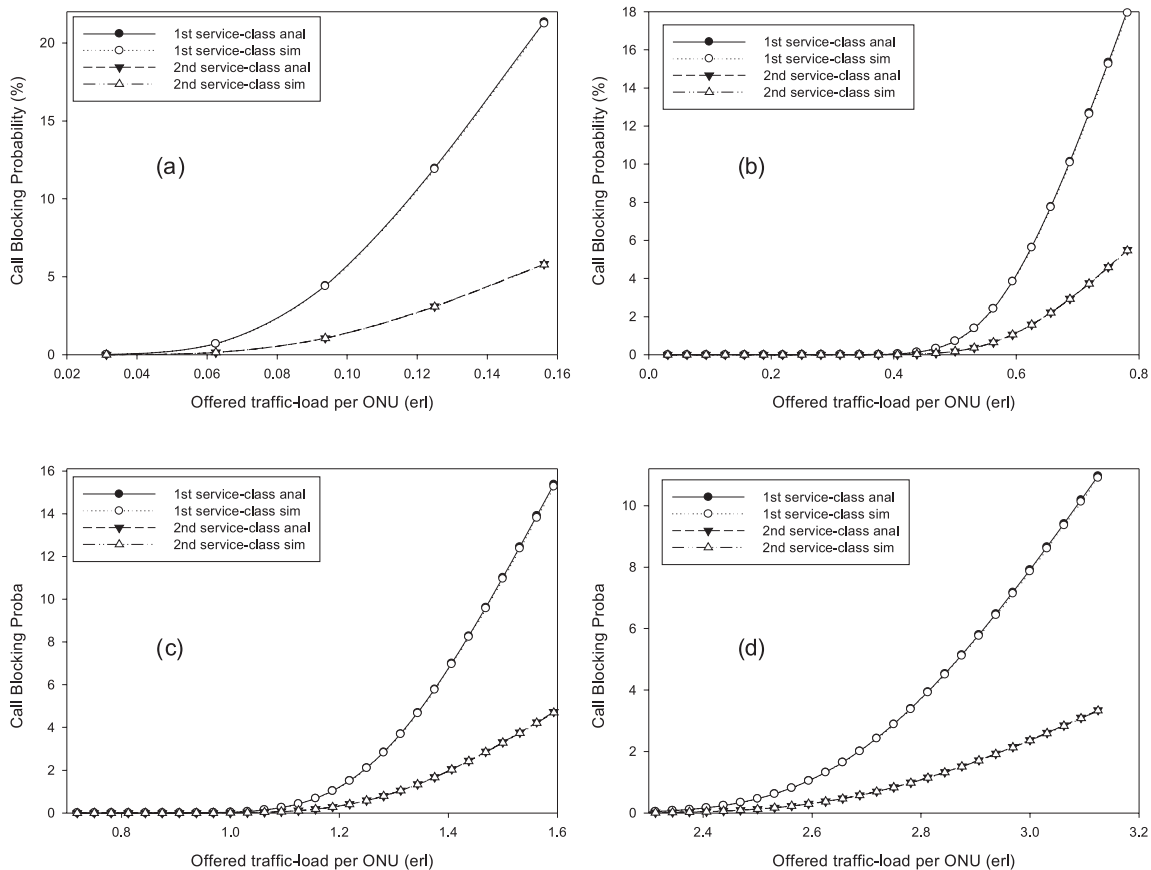

Fig. 4 Analytical and simulation CBP results for 4 different values of the optical fiber capacity

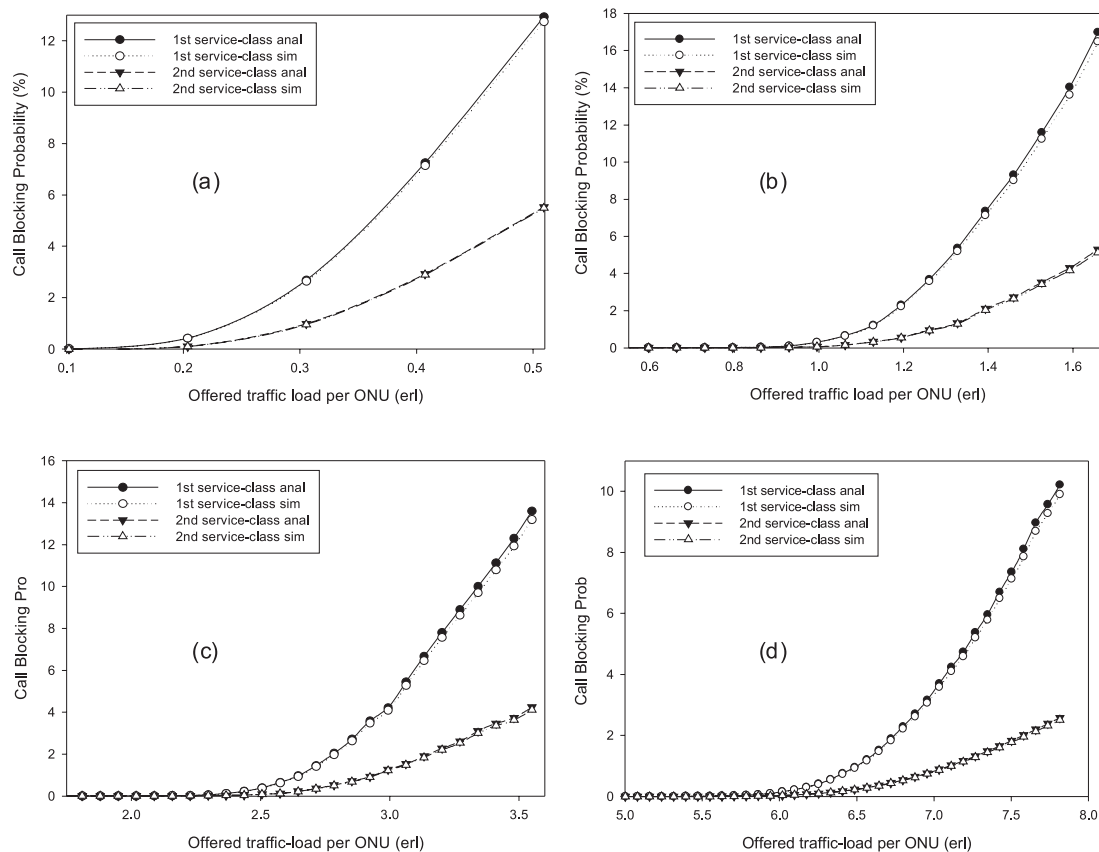

Fig. 5 Analytical and simulation CBP results for the secondary wavelength for 4 different values of the wavelength capacity

References

- [1] MUKHERJEE, B.: *Optical WDM Networks*, Springer, 2006.
- [2] SIVALINGAM, K. M., SUBRAMANIAM, S.: *Emerging Optical Network Technologies*, Springer Science, 2005.
- [3] KRAMER, G.: *Ethernet Passive Optical Networks*, McGraw Hill, 2005.
- [4] KOONEN, T.: *Fiber to the Home/Fiber to the Premises: What, Where, and When?*, Proc. of the IEEE, Vol. 94, No. 5, pp. 911-934, May 2006.
- [5] LIN, C.: *Broadband Optical Access Networks and Fiber-to-the-Home*, Wiley, 2006.
- [6] EFFENBERGER, F., CLEARY, D., HARAN, O., KRAMER, G., DING LI, R., ORON, M., PFEIFFER, T.: *An Introduction to PON Technologies*, IEEE Communications Magazine, pp. S17-S25, March 2007.
- [7] DAVEY, R., BOURGART, F., MCCAMMON, K.: *Options for Future Optical Access Networks*, IEEE Communications Magazine, October, 2006.
- [8] KAUFMAN, J. S.: *Blocking in a shared resource environment*, IEEE Transactions on Communications, 10/1981, pp.1474-1481.
- [9] ROBERTS, J. W.: *A service system with heterogeneous user requirements*, G. Pujolle (Ed.), Performance on Data Communication Systems and their Applications, North Holland, Amsterdam, 1981, pp. 423-431.
- [10] HUANG, Q., KO, K-T., IVERSEN, V. B.: *An Approximation Method for Multiservice Loss Performance in Hierarchical Networks*, L. Mason, T. Drwiega, and J. Yan (Eds.): ITC 2007, LNCS 4516, pp. 901-912.
- [11] UEDA, H., OKADA, K., FORD, B., MAHONY, G., HORNUNG, S., FAULKNER, D., ABIVEN, J., DUREL, S., BALLART, R., ERICKSON, J.: *Deployment status and common technical specifications for a B-PON system*, IEEE Communication Magazine, 12/2001, pp. 134-141.
- [12] ITU-T Recommendation G.983.1, Broadband Optical Access Systems Based on Passive Optical Networks (PON), 2005.

- [13] DHAINI, A. R., ASSI, C. M., MAIER, M., SHAMI, A.: *Dynamic Wavelength and Bandwidth Allocation in Hybrid TDM/WDM EPON Networks*, IEEE/OSA Journal of Lightwave Technology, 1/2007, pp. 277-286.
- [14] GUTIERREZ, D., SHAW, W.-T., AN, F.-T., KIM, K. S., HSUEH, Y.-L., ROGGE, M., WONG, G., KAZOVSKY, L. G.: *Next generation optical access networks*, (Invited Paper), Proc. of IEEE/Create-Net BroadNets, Oct. 2006.
- [15] LAM, C.: *Passive Optical Networks*, Principles and Practise, Academic Press, 2007.
- [16] GROBE, K., ELBERS, J.-P.: *PON in Adolescence: From TDMA to WDM-PON*, IEEE Communications Magazine, pp. 26-34 January 2008.
- [17] FRIGO, N. J., IANNONE, P., REICHMANN, K. C.: *Spectral slicing in WDM passive optical networks for local access*", in Proc. ECOC 1998, pp. 119-120.
- [18] FRIGO, N. J., IANNONE, P. P., REICHMANN, K. C., WALKER, J. A., GOOSSEN, K. W., ARNEY, S. C., MURPHY, E. J., OTA, Y., SWARTZ, R. G.: *Demonstration of performance-tiered modulators in a WDM PON with a single shared source*, Proc. of ECOC 1995, pp. 441-444.

Ronny Henker – Andrzej Wiatrek – Kai-Uwe Lauterbach – Markus Junker – Thomas Schneider
 Max J. Ammann – Andreas T. Schwarzbacher*

A REVIEW OF SLOW- AND FAST-LIGHT BASED ON STIMULATED BRILLOUIN SCATTERING IN FUTURE OPTICAL COMMUNICATION NETWORKS

Slow- and Fast-Light has been investigated during the last years as a powerful tool to reduce and increase the group velocity of light pulses by light. It has enjoyed much recent interest because of the practical applications for telecommunication and information systems. Among these are optical signal processing, radio frequency-photonics, nonlinear optics and time domain spectroscopy. Furthermore, it can be seen as a key technology for optical delay lines, buffers, equalizers and synchronizers in packet switched networks. For a realization, there are different methods and material systems possible. Among them the nonlinear effect of stimulated Brillouin scattering (SBS) is of special interest. This article gives an overview about the fundamentals and some experimental results of the Slow- and Fast-Light effect based on the SBS in optical fibers.

1. Introduction

Today's data networks consist of optical fibers for the transport of data signals and network nodes for their switching through the net. The data traffic is nearly doubled in transport networks every year. But, this is not a big problem for optical transmission technologies because every fiber is able to transmit more than 100 channels with data rates of 10 or 40 Gbit/s. Contrary to this, the capacity of network nodes is doubled only every 18 months [1].

Inside every node the optical pulses are converted into electrical signals to process and switch them. After that they are converted back into the optical domain to transmit them to the next

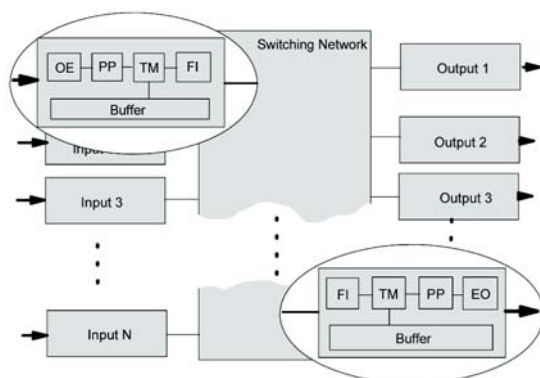

Fig. 1 Schematic setup of a network node. OE; optical-electrical conversion, PP; packet processor, TM; traffic manager, FI; fabric interface, EO; electrical-optical conversion [2].

node over the fiber. For the processing of the signal in the node it is necessary to store the pulses for a certain time otherwise collisions will occur. Therefore, every signal channel needs its own card for the handling which is shown in Fig. 1.

If the data traffic increases in the networks the number of channels and so the number of handling cards increases as well. Then, one problem is that the physical dimensions of the nodes expand. Hence, the distance between the in- and the output of the card increases drastically. Electrical signals with a high frequency cannot pass long distances without suffering significant losses and distortions. But, for optical signals this is not a problem. That is why there has began a reinforced development of optical alternatives to electrical network nodes. These optical nodes should take over all functions of the electrical ones including signal buffering.

Most functions of such an optical network node have already been shown [3], [4]. But, up to now the intermediate storage of the signals is not a satisfactorily solved problem. For an ideal processing the packets have to be buffered on the in- and outputs of the network channel cards. An optical buffer can be defined as follows [5]:

- The data stream is completely optically. No optical-electrical-optical conversion is proceeded.
- The buffer stores the signal for a time ΔT only with low distortions and attenuations.
- The delay time ΔT is variable and externally controllable.

The easiest way to realize an optical pulse delay is to send the signal into a delay line with a fixed length L , e. g. an optical fiber. Inside the fiber segment the signal propagates with the group

* Ronny Henker¹, Andrzej Wiatrek¹, Kai-Uwe Lauterbach¹, Markus Junker¹, Thomas Schneider¹, Max J. Ammann², Andreas T. Schwarzbacher²

¹Hochschule für Telekommunikation Leipzig (FH), Leipzig, Germany, E-mail: ronny.henker@hft-leipzig.de

²School of Electronic & Communications Engineering, Dublin Institute of Technology, Kevin Street Dublin 8, Ireland

velocity v_g which depends on the group index n_g of the transmitting medium. If the waveguide dispersion is neglected it is:

$$v_g = \frac{c}{n_g} \quad (1)$$

with c as the speed of light in vacuum. The time delay is caused by the fiber length and can be written as $\Delta T = aL/v_g$ with a as the number of passes through the delay line. Hence, the storage capacity and the number of bits, respectively, depend on ΔT . But, if the number of bits is longer interferences occur at the beginning and the end of the packet. And, if the packet is coupled into the fiber once it can be read out only after a whole circulation.

The main problem of this method is that the storage time is fixed and cannot be varied. But, in data networks the storage time has to be variable because the arrival time is stochastic and not quantized. Furthermore, the attenuation of the signal in long passive delay lines is another problem. Due to these disadvantages the so-called "Slow-Light" concept which could provide a way out of these problems has been discussed and developed for the last few years.

2. Slow and Fast-Light

For Slow- and Fast-Light the time delay does not depend on the length of a fiber but on the value of the group index n_g . According to Eq. (1) the optical signal can be slowed down (Slow-Light) or accelerated (Fast-Light) if it is possible to change n_g along the propagation path. Thereby, the group index and the time delay depend on the frequency ω [2]:

$$n_g = n(\omega) + \omega \frac{dn(\omega)}{d\omega}, \quad (2)$$

with n as the real part of the refractive index of the material. Due to a positive change of the frequency dependence of the refractive index $\omega dn/d\omega$ the group index increases and hence the optical signals are delayed otherwise they are accelerated.

A large change of the group delay is caused automatically by a strong material dispersion. Mostly, such a dispersion occurs if the frequency of the light is nearby material resonances which results in absorption or amplification processes [2]. On the so-called Slow-Light effect these resonances are created artificially. For this, different methods and material systems can be used. The slowing down of light signals was shown for example in ultra cold [6] and hot atomic-gases [7], in semiconductor-nanostructures [5], quantum-well [8] and quantum-dot systems [9] as well as in waveguides which work like photonic crystals [10]. Furthermore, amplification effects like in Erbium-doped fiber amplifiers (EDFA) [11] and semiconductor amplifiers (SOA) [12] can also be used. All these methods have the disadvantage that the delay is very low and the effort is high. Some of these methods are also difficult to integrate into optical networks. In contrast to this, nonlinear effects in a fiber are more effective to delay optical signals. They have the great advantage that the fibers themselves are the Slow-light medium and can be integrated seamlessly in optical systems. For example four wave mixing together with the fiber dispersion [13] and Raman scattering [14] can be used to create Slow-Light. But the effect of SBS is of very special interest [15].

3. Brillouin scattering

The SBS has several advantages among the other Slow-Light methods. It needs just small pump powers for high time delays. The systems are very easy to implement and can be built up with standard components of telecommunications. Furthermore, the SBS works in all fiber types in their entire transparency range what makes the systems very flexible. In [16] it has been shown that the SBS can influence the group velocity over a wide range from 71000 km/s to vacuum superluminal velocity.

The SBS is a nonlinear effect with a low threshold which is caused by interactions between the incident light and the material. The principle can be seen on the left hand side of Fig. 2. If a strong pump wave with the frequency f_p is propagating through

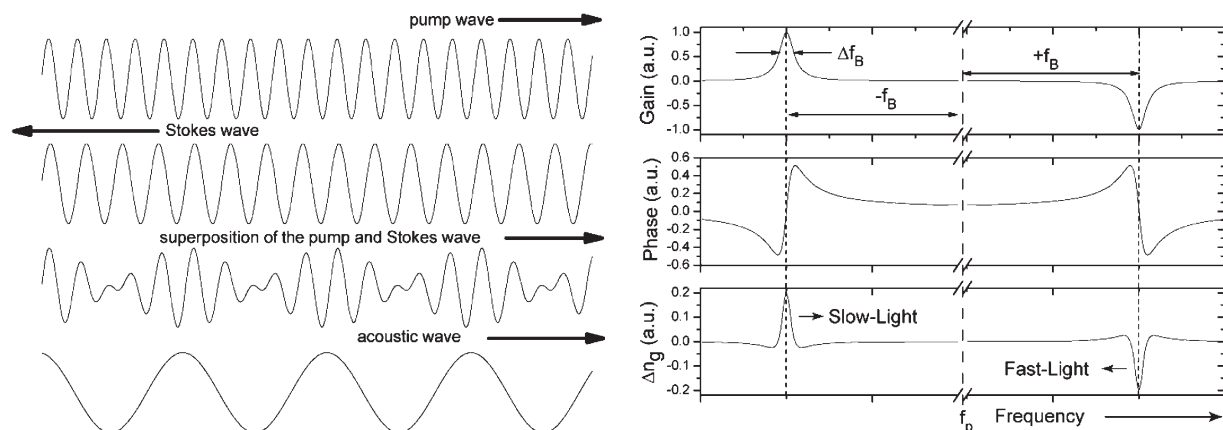

Fig. 2 Principle of SBS (left) [17]; Gain and loss (top), phase (middle) and group index change (bottom) via SBS (right) [2].

a waveguide a part of the optical power is backscattered on density fluctuations and a Stokes-wave occurs. This superimposes with the pump wave and creates a density wave in direction to the pump wave. There, more pump power is scattered and the process is built up. From a certain pump power, the Brillouin threshold, it becomes stimulated. Thereby, the pump and the density wave have a relative speed to each other, and hence the Stokes-wave is shifted in frequency by the so-called Brillouin shift f_B which is around 11 GHz in a standard single mode fiber (SSMF) at a pump wavelength of 1550 nm [17].

As can be seen in the upper diagram on the right hand side of Fig. 2 a gain and a loss is created in the fiber, if the input power is under the threshold. Thereby, the gain is downshifted and the loss is upshifted by f_B . Furthermore, they come along with a phase change and with a change of the group index (middle and bottom part on the right hand side of Fig. 2). Hence, within the gain and the loss a counter propagating signal wave can be amplified or attenuated. But, it can also be delayed or accelerated because, according to Eq. (2), the gradient of the group index is positive for $f_p - f_B$ and negative for $f_p + f_B$.

4. Slow and Fast-Light based on SBS

The output pulse $A(\omega, z)$ after the Slow-Light system relating to the input pulse $A(\omega, 0)$ is:

$$A(\omega, z) = A(\omega, 0)e^{jk(\omega)z} \quad (3)$$

with z as the length of the medium and $k(\omega)$ as the complex wave number. The propagation of a pulse through the Slow-Light medium can be described by the complex wave number [17], [18]:

$$k(\omega) = \sum_{i=0}^{\infty} \frac{k_i(\omega - \omega_0)^i}{i!} \quad \text{with } k_i = \left[\frac{d^i k}{d\omega^i} \right]_{\omega=\omega_0} \quad (4)$$

where ω_0 is the line center frequency. The first derivation $k_1 = dk/d\omega$ corresponds to the reciprocal group velocity which leads to the transmission time of the signal whereas the second derivation $k_2 = d^2k/d\omega^2$ is the group velocity dispersion (GVD) which leads to a distortion of the pulses. Without an influence of the SBS k can be expressed by $k = \omega n_0/c$ with n_0 as the complex refractive index in the fiber. So, the time delay due to the propagation through the fiber is $\Delta T = z(k_1 - 1/c) = z(n_0 - 1)/c$. For

a single Brillouin gain with a Lorentzian distribution the complex wave number has to be expanded to [19]:

$$k(\omega) = \frac{n_0}{c} \omega + \frac{g_1}{z} \left(\frac{\gamma_1}{(\omega - \omega_0) + j\gamma_1} \right), \quad (5)$$

with $\gamma_1 = \pi \Delta f_B$ as the half width at half maximum (HWHM) bandwidth of the gain and $g_1 = gPL_{eff}/A_{eff}$ as the line center gain where g is the Brillouin coefficient, P is the pump power, L_{eff} and A_{eff} are the effective length and area of the fiber. The imaginary part of Eq. (5) leads to an amplification of the pulses and the real part to a phase change. Furthermore, the derivation of the real part leads to the group index change which causes the Slow-Light delay. Then, the time delay in the line center is $\Delta T = z(n_0 - 1)/c + g_1/\gamma_1$. Hence, the time delay only caused by the SBS can be written as:

$$\Delta T_{SBS} = \frac{g_1}{\gamma_1}. \quad (6)$$

As can be seen from Eq. (6), the time delay depends on the gain and on the pump power on the one hand and on the Brillouin bandwidth on the other hand. If not a Brillouin gain but a Brillouin loss is used g_1 and so the time delay becomes negative. Hence, the pulse is accelerated and Fast-Light is achieved.

A principle experimental setup for the generation of Slow- and Fast-Light is shown on the left hand side of Fig. 3. A signal laser creates the carrier wave with the frequency f_s for the pulses which are generated by a pulse generator combined with a Mach-Zehnder modulator (MZM). Normally, we use Gaussian shaped pulses at wavelengths of around 1550 nm. Then, they are coupled into a 50 km long SSMF which is our Slow- and Fast-Light medium. From the other side a pump wave (Pumplaser) with the frequency f_p of a DFB-laser diode is coupled into the same fiber via an optical circulator (C). The pump wave creates a Brillouin gain at $f_p - f_B$ and a loss at $f_p + f_B$ inside the fiber. If the pulse frequency is equal to the gain, the pulses are delayed and if it is equal to the loss, they are accelerated. Thereby, the pulse power, the pump power and hence the time delay can be controlled by tunable optical attenuators or EDFAs which are not shown here. Finally, the delayed or accelerated pulses are detected by a photodiode (PD) on port 3 of the circulator and interpreted via an oscilloscope (Osci). A typical result of delayed pulses is shown on the right hand side of Fig. 3.

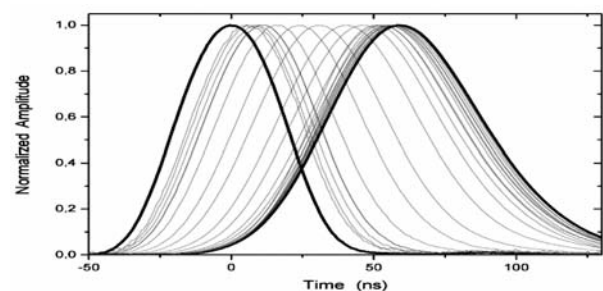
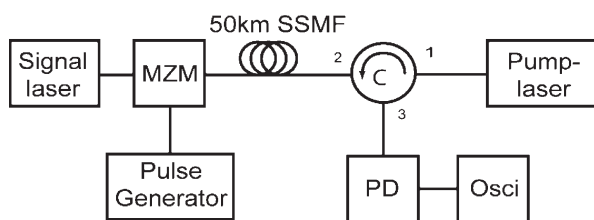

Fig. 3 Principle experimental setup and delayed pulses.

5. Limits of the method

The SBS also has several disadvantages. First, the bandwidth of the SBS in a SSMF is with around 30 MHz very narrow. On the one hand, this limits the maximum delayable data rate drastically. On the other hand, high time delays can be achieved as can be seen in Eq. (6). But, this time delay is accompanied by pulse distortions (pulse shape broadening) due to the spectral narrowing by the SBS gain and the group velocity dispersion (GVD) with higher orders of Eq. (4). The pulse broadening factor B as the relation between the output τ_{out} and input pulse width τ_{in} can be described by [20]:

$$B = \frac{\tau_{out}}{\tau_{in}} = \sqrt{1 + \frac{16 \ln 2}{\tau_{in}^2 \gamma_1^2} g_1}. \tag{7}$$

Second, the maximum time delay is limited due to the saturation of the Brillouin amplification process (pump depletion) with increasing pump powers. In most of the Slow-Light systems the maximum time delay is around 30 ns by using SBS with the natural bandwidth. Hence, different mechanisms for tailoring the shape of the Brillouin spectrum have been investigated.

The natural Brillouin bandwidth Δf_B is defined by parameters of the used fiber. But, the resulting bandwidth γ is based on a convolution of the bandwidth of the pump signal Δf_p and Δf_B [17]:

$$\gamma = \pi(\Delta f_p \otimes \Delta f_B). \tag{8}$$

Hence, the Brillouin bandwidth can easily be broadened by direct modulation of the pump source with a noise signal for instance [21]. If only one gain pump source is used this provides a bandwidths up to the value of f_B [22]. We were able to show that it can be further enhanced to more than 10 GHz by using multiple gain pump sources [23]. A broad gain provides higher delayable data rates and according to Eq. (7) it compensates the pulse distortions partially because the gain does not restrict the spectral distribution of the pulse and the top of the spectrum becomes uniform [24]. However, this decreases the time delay significantly, as can be seen from Eq. (6).

An enhancement of the maximum time delay can be achieved by a superposition of Brillouin gain and loss spectra which decouples the time delay from the amplifier gain. Therefore the setup in

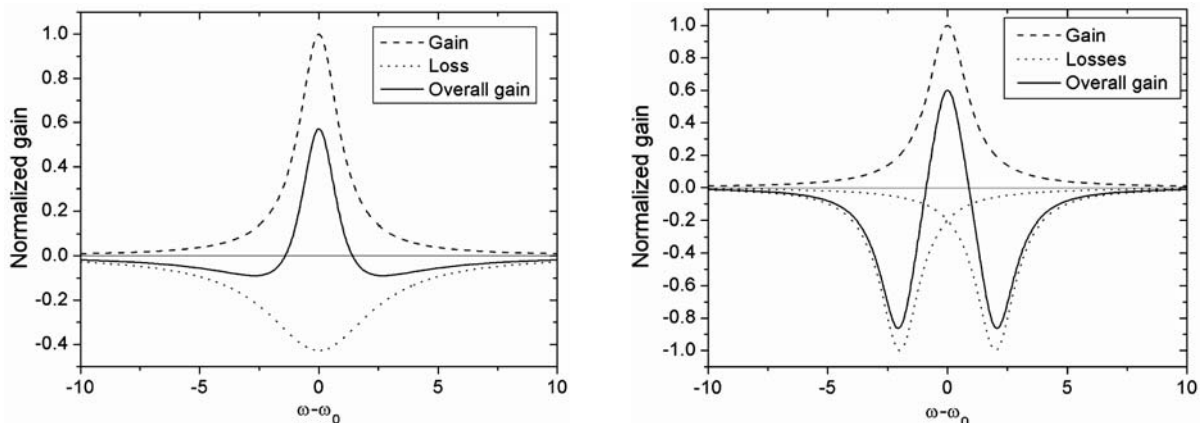

Fig. 4 Superposition of a Brillouin gain with a broadened loss (left) and two losses at its wings (right).

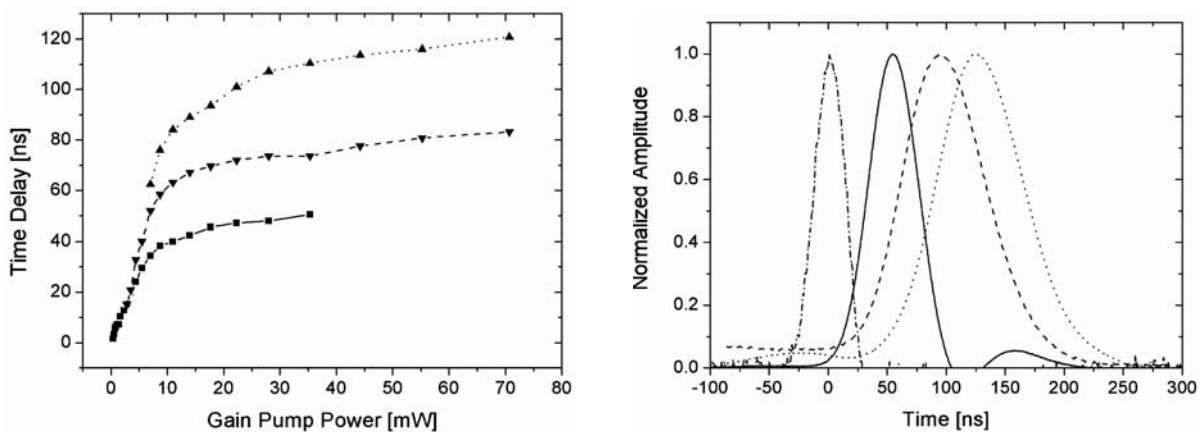

Fig. 5 Time delay vs. gain pump power (left) and pulse time functions with the maximum time delay (right) for a normal gain (solid), a gain superimposed with a broadened loss (dashed) and superimposed with two losses at its wings (dotted); reference (dashed-dotted).

Fig. 3 has to be extended with further pump sources. Two superposition methods and some measurement results are shown in Fig. 4 and Fig. 5.

A simple method for a realization of the time delay enhancement is to superimpose the Brillouin gain with a broadened Brillouin loss (left diagram of Fig. 4) [25], [26]. The delay depends on the gradient of the gain whereas the amplification and the saturation respectively is a function of the maximum height of the gain. With the superposition of the Brillouin spectrum the gradient is not changed but the height is reduced. Hence, higher pump powers are possible which leads to a higher time delay. With this method we were able to achieve time delays up to 100 ns which corresponds to around three times the initial pulse width. But, due to a doubling of the pulse width the effective time delay – the ratio between the time delay and the output pulse width – was decreased (dashed lines in Fig. 5).

A method which is more effective is the superposition of a Brillouin gain with two losses at its wings (right diagram of Fig. 4) because this enables even higher time delays because the gradient of the gain is changed in addition to the gain-delay-decoupling. Furthermore, a designing of the Brillouin spectrum by varying the separation of the losses is possible. For this, the complex wave number can be written as [19]:

$$k(\omega) = \frac{n_0}{c} \omega + \frac{g_1}{z} \left(\frac{\gamma_1}{(\omega - \omega_0) + j\gamma_1} \right) - \frac{g_2}{z} \left(\frac{\gamma_2}{(\omega - (\omega_0 \pm \delta)) + j\gamma_2} \right), \quad (9)$$

with the Brillouin coefficient g_2 , the HWHM-bandwidth γ_2 and with the separation of the losses 2δ . With this configuration the

tailoring of the Brillouin spectrum can be done by a variation of different parameters. At first, the time delay and the bandwidth depends directly on δ . Furthermore, the ratio between pump powers g_2/g_1 and the ratio between the bandwidths γ_2/γ_1 of the losses and the gain have a large influence. Hence, different operating points with different properties can be adjusted [27], as can be seen in Fig. 6.

For $g_1 = g_2$ we determined the region there the maximum time delay can be achieved at $\delta \approx \gamma\sqrt{3}$. In this case it makes no difference if the gain is broadened or not. For equal bandwidths the optimal points of the highest bandwidth (lowest distortions) and so the highest effective time delay occurs at the same position (left diagram of Fig. 6). But, if the gain bandwidth is broadened – here to three times of the loss bandwidth – the region of the maximum bandwidth and so the maximum effective time delay is shifted to a higher value of $\delta = 2.25\gamma$ (right diagram of Fig. 6).

With equal gain and loss bandwidths and a loss separation of $\delta = \gamma\sqrt{3}$ we were able to enhance the maximum time delay to around 120 ns which corresponds to four times the initial pulse width [19]. But, the pulse distortion is still high which reduces the effective time delay again (dotted lines in Fig. 5).

To reduce the distortions the gain spectrum can be broadened additionally to get a broad and steep Brillouin profile with a flat

top. Then, the gain becomes Gaussian shaped and the complex wave number changes to [19]:

$$k(\omega) = \frac{n_c}{c} \omega + \frac{g_1}{jz} \left(e^{-\frac{(\omega - \omega_0)^2}{\gamma_G}} \cdot \text{erfc} \left(-j \frac{\omega - \omega_0}{\gamma_0} \right) \right) - \frac{g_2}{z} \left(\frac{\gamma_2}{(\omega - (\omega_0 \pm \delta)) + j\gamma_2} \right), \quad (10)$$

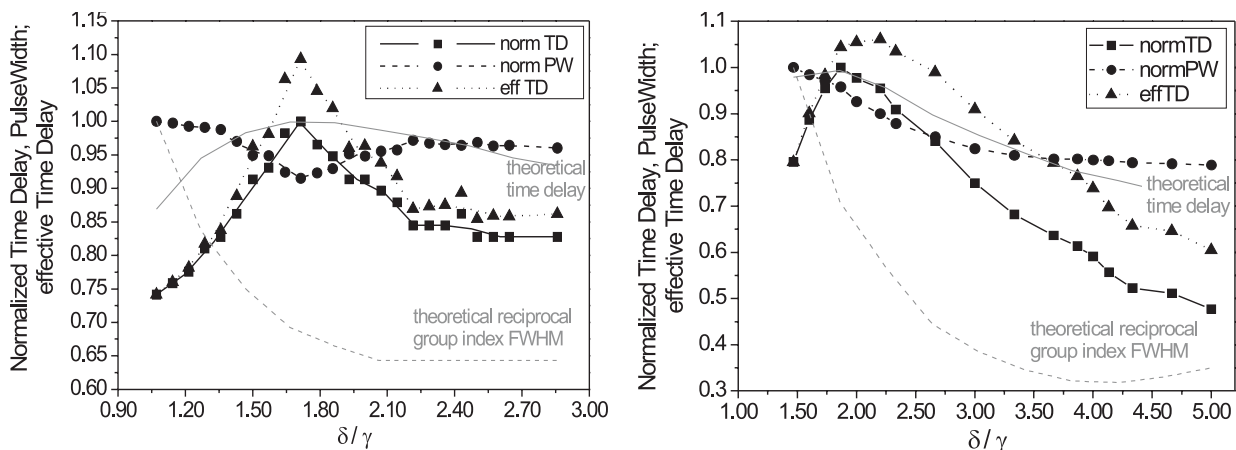

Fig. 6. Normalized time delay (normTD), pulse width (normPW) and effective time delay (effTD) vs. δ for a natural (left, $\gamma_1 = \gamma_2$) and a broadened (right, $\gamma_G = 3\gamma_2$) Brillouin gain.

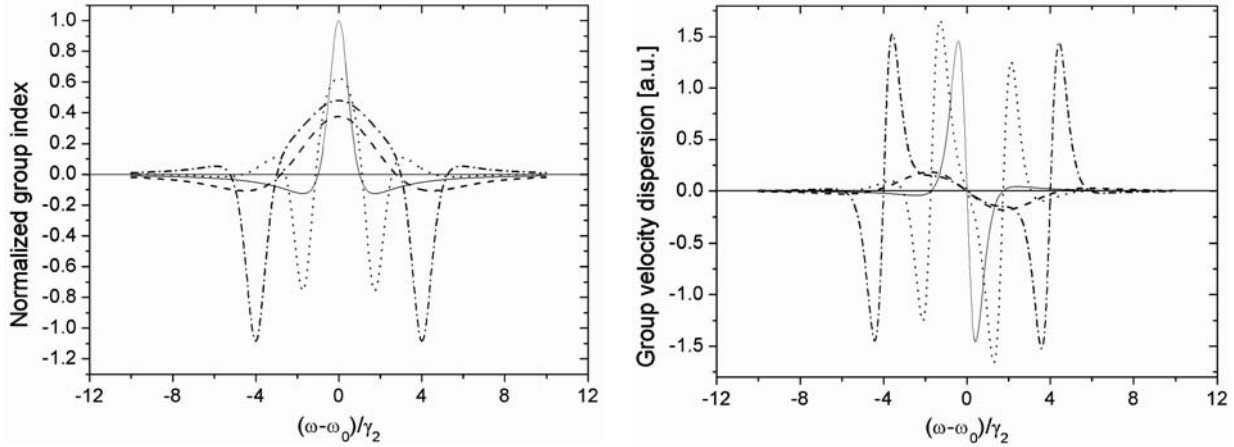

Fig. 7. Normalized group index (left) and GVD (right) for a natural gain (solid) and three times broadened gain (dashed) with losses at $\delta = \pm 1.7\gamma_2$ (dotted) and $\delta = \pm 4\gamma_2$ (dashed-dotted).

with γ_G as the 1/e-bandwidth of the gain and $erfc()$ as the complementary error function. Simulations have been shown that a reduction of the GVD next to the bandwidth-broadening is possible with this system [28]. In Fig. 7 it is shown that by a broadening of the gain and a superposition with two losses at its wings the group index and so the time delay is indeed decreased, but the GVD runs linearly with a very small slope in the middle of the Brillouin profile. Therefore, the two operating points for the maximum time delay or the maximum bandwidth could be chosen. In comparison to that, a single natural gain would provide a higher time delay but also a higher GVD and a single broadened gain would provide a lower GVD but at the same time a lower time delay. With a gain bandwidth broadened by the factor of two and a loss separation of 60 MHz we achieved a distortion reduction of 23 % for a delay of one initial pulse width [29].

Nevertheless, the broadening is still a limiting factor which decreases the storage capability and the quality of the Slow-Light system. Recently, it has been shown theoretically that a pulse delay without a broadening could be produced by another method consisting of a broadband gain with a narrow loss in its line center [30]. This is a very important achievement because any desired time delay would be possible without a distortion by connect several delay lines in series. But, due to the broad gain the time delay of any stage would be very small and further decreased by the loss, so that a lot of segments would be necessary and the system would become very complex.

In [31] we have shown in theory and for the first time, to the best of our knowledge, experimentally that a zero-broadening and even a compression of delayed pulses are possible with our system as described in [19] and [29]. Therefore, Gaussian shaped input pulses with a temporal width τ_{in} of 1.5 ns were delayed to approximately 1.5 Bit in a SSMF with a length of 25 km. The non-delayed output pulses had a width τ_{ref} of 1.9 ns owing to the fiber dispersion. By an optimization of the separation of the two losses and the loss-gain-ratio it was possible to compress the delayed pulse to 80 % of the reference pulse width, as can be seen in Fig. 8. Hence,

the output pulse width comes very close to that for the input pulse width. However, this comes at the expense of a new pulse shape distortion where a small part separates from the main pulse and forms an additional one. But, this part is not as large as the main pulse. Furthermore, we believe that it can be prevented by further optimizations.

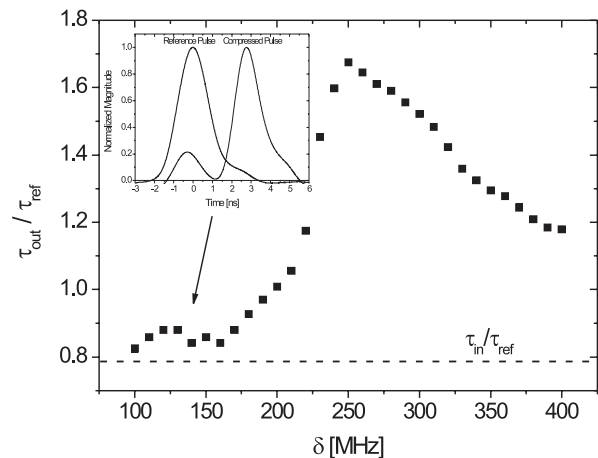

Fig. 8. Fractional output pulse width as a function of the loss separation; the inset shows the delayed compressed pulse in comparison to the non-delayed reference pulse.

How much the effective time delay of these procedures is limited theoretically is not really known at this moment. In [32] it is supposed that the maximum time delay – for a maximum tolerable pulse broadening factor of $B = 2$ – is:

$$\left(\frac{\Delta T_{SBS}}{\tau_{in}} \right)_{\max} = \frac{3}{2} \gamma \tau_{in} . \quad (11)$$

By choosing γ arbitrarily the effective time delay could reach any dimension. Another assumption is shown in [33] where the gain G for buffering N Bits has to be:

$$G \approx 50N^{\frac{2}{3}}. \quad (12)$$

For a storage of more than 5 Bits the gain should be higher than 560 dB which is not realistic. Even for a 3 Bit delay 260 dB would be needed. But, we used a gain of only 16 dB [26]. Hence, in Eq. (12) there is disregarded the opportunity to decouple the time delay and the gain.

In general, the achievable delay in SBS-based Slow-Light systems depends on the saturation gain and therefore on the input pulse power. For our system of a superposition of a Brillouin gain with two losses at its wings an enhancement of the time delay by a factor of 2 up to 9.5 could be achieved for input pulse powers of -60 dBm and 0 dBm [34].

6. Conclusions

In this paper an overview about the fundamentals, the limits and achieved experimental results of Slow- and Fast-Light systems

based on SBS was given. The existing experimental setups of such systems are still far away from real practical applications and the final limits are still unknown nowadays. But, there are reinforced investigations on this topic worldwide. Next to the fundamental interest on the control of the light speed in media Slow- and Fast-Light can be seen as a key technology for future packet switched optical networks.

Acknowledgements

We gratefully acknowledge the help of J. Klinger from HfT Leipzig and the loan of the equipment of C. Schaeffer from TU-Dresden and of K. Buse from the University in Bonn. M. Junker, K.-U. Lauterbach and R. Henker were financially supported by Deutsche Telekom.

References

- [1] BERNASCONI, P.; SIMSARIAN, J. E.; GRIPP, J.; DULK, M.; NEILSON, D. T.: *Toward Optical Packet Switching*, Photonics Spectra, 03/2006, pp. 4-92.
- [2] SCHNEIDER, T.; HENKER, R.; LAUTERBACH, K.-U.; JUNKER, M.: *Slow und Fast Light in photonischen Netzen - ein Überblick*, Proc. 8. ITG-Fachtagung Photonische Netze, vol. 201, 2007, pp. 17-24.
- [3] *Journ. of Lightw. Technol.* (Special Issue on Optical Networks), vol. 18, 12/2000.
- [4] NAGATSU, N.: *Photonic Network Design Issues and Applications to the IP Backbone*, Journ. of Lightw. Technol., vol. 18, no. 12, 12/2000, pp. 2010-2018.
- [5] CHANG-HASNAIN, C. J.; KU, P.-C.; KIM, J.; CHUANG, S.-L.: *Variable Optical Buffer Using Slow Light in Semiconductor Nanostructures*, Proc. IEEE, vol. 91, 2003, pp. 1884-1897.
- [6] HAU, L. V.; HARRIS, S. E.; DUTTON, Z.; BEHROOZI, C. H.: *Light speed reduction to 17 m/s in an ultracold atomic gas*, Nature, vol. 397, 1999, pp. 594-598.
- [7] KASH, M. M.; SAUTENKOV, V. A.; ZIBROV, A. S.; HOLLBERG, L.; WELCH, G. R.; LUKIN, M. D.; ROSTOVTSSEV, Y.; FRY, E. S.; SCULLY, M. O.: *Ultraslow group velocity and enhanced nonlinear optical effects in a coherently driven hot atomic gas*, Phys. Rev. Lett., vol. 82, 06/1999, pp. 5229-5232.
- [8] KU, P.-C.; SEDGWICK, F.; CHANG-HASNAIN, C. J.; PALINGINIS, P.; LI, T.; WANG, H.; CHANG, S.-W.; CHUANG, S.-L.: *Slow light in semiconductor quantum wells*, Opt. Lett., vol. 29, 2004, pp. 2291-2293.
- [9] POEL, M. van der; MORCK, J.; HVAM, J.: *Controllable delay of ultrashort pulses in a quantum dot optical amplifier*, Opt. Express, vol. 13, 2005, pp. 8032-8037.
- [10] GERSEN, H.; KARLE, T. J.; ENGELN, R. J. P.; BOGAERTS, W.; KORTERIK, J. P.; HULST, N. F. VAN; KRAUSS, T. F.; KUIPERS, L.: *Real-space observation of ultraslow light in photonic crystal waveguides*, Physical Review Letters, vol. 94, 2005, 073903.
- [11] LEPESHKIN, N. N.; SCHWEINSBERG, A.; BIGELOW, M. S.; GEHRING, G.; BOYD, R. W.: *Slow and fast light propagation in erbium-doped fiber*, Quantum Electronics and Laser Science Conference (QELS'05), vol. 1, 05/2005, pp. 220-222.
- [12] USKOV, A. V.; SEDGWICK, F. G.; CHANG-HASNAIN, C. J.: *Delay limit of slow light in semiconductor optical amplifiers*, IEEE Photonics Technology Letters, vol. 18, 03/2006, pp. 731-733.
- [13] SHARPING, J. E.; OKAWACHI, Y.; HOWE, J. VAN; XU, C.; GAETA, A. L.: *All-optical, continuously tunable, nanosecond pulse delay using wavelength conversion and fiber dispersion*, Conference on Lasers and Electro-Optics (CLEO), vol. 2, 05/2005, pp. 971-973.
- [14] SHARPING, J. E.; OKAWACHI, Y.; GAETA, A. L.: *Wide bandwidth slow light using a Raman fiber amplifier*, Opt. Express, vol. 13, 2005, pp. 6092-6098.
- [15] OKAWACHI, Y.; BIGELOW, M. S.; SHARPING, J. E.; ZHU, Z. M.; SCHWEINSBERG, A.; GAUTHIER, D. J.; BOYD, R. W.; GAETA, A. L.: *Tunable all-optical delays via Brillouin slow light in an optical fiber*, Phys. Rev. Lett., vol. 94, 2005, 153902.
- [16] GONZALEZ-HERRAEZ, M.; SONG, K.-Y.; THAVENAZ, L.: *Optically controlled slow and fast light in optical fibers using stimulated Brillouin scattering*, Applied Physics Letters, vol. 87, 2005, 081113.

- [17] SCHNEIDER, T.: *Nonlinear Optics in Telecommunications*, Springer-Verlag, Berlin, 2004.
- [18] STENNER, M. D.; NEIFELD, M. A.; ZHU, Z.; DAWES, A. M. C.; GAUTHIER, D. J.: *Distortion management in slow-light pulse delay*, Opt. Express, vol. 13, 2005, pp. 9995-10002.
- [19] SCHNEIDER, T.; HENKER, R.; LAUTERBACH, K.-U.; JUNKER, M.: *Comparison of delay enhancement mechanisms for SBS-based slow light systems*, Opt. Express, vol. 15, 2007, pp. 9606-9613.
- [20] ZHU, Z.; GAUTHIER, D. J.; OKAWACHI, Y.; SHARPING, J. E.; GAETA, A. L.; BOYD, R. W.; WILLNER, A. E.: *Numerical Study of All-Optical Slow-Light Delays via Stimulated Brillouin Scattering in an Optical Fiber*, J. Opt. Soc. Am. B, vol. 22, 2005, pp. 2378-2384.
- [21] GONZALEZ-HERRAEZ, M.; SONG, K. Y.; THEVENAZ, L.: *Arbitrary-Bandwidth Brillouin Slow Light in Optical Fibers*, Opt. Exp., vol. 14, 02/2006, pp. 1395-1400.
- [22] ZHU, Z.; DAWES, A. M. C.; GAUTHIER, D. J.; ZHANG, L.; WILLNER, A. E.: *Broadband SBS slow light in an optical fiber*, J. Lightwave Technol., vol. 25, 2007, pp. 201-206.
- [23] SCHNEIDER, T.; JUNKER, M.; LAUTERBACH, K.-U.: *Potential ultra wide slow-light bandwidth enhancement*. Opt. Express, vol. 14, 2006, pp. 11082-11087.
- [24] PANT, R.; STENNER, M. D.; NEIFELD, M. A.: *Designing Optimal Gain Profiles for Slow-Light Applications*, Proc. of SPIE, vol. 6482, 2007, 64820R.
- [25] CHIN, S.; GONZALEZ-HERRAEZ, M.; THÉVENAZ, L.: *Zero-gain slow & fast light propagation in an optical fiber*, Opt. Express, vol. 14, 2006, pp. 10684-10692.
- [26] SCHNEIDER, T.; JUNKER, M.; LAUTERBACH, K.-U.: *Time delay enhancement in stimulated Brillouin-scattering-based slow-light systems*, Opt. Lett., vol. 32, 2007, pp. 220-222.
- [27] HENKER, R.; WIATREK, A.; LAUTERBACH, K.-U.; SCHNEIDER, T.; AMMANN, M. J.; SCHWARZBACHER, A. T.: *Optimization of the Brillouin spectrum for fiber based slow light systems*, Proc. of CLEO'08, 2008, CThE1.
- [28] HENKER, R.; WIATREK, A.; LAUTERBACH, K.-U.; AMMANN, M. J.; SCHWARZBACHER, A. T.; SCHNEIDER, T.: *Group velocity dispersion reduction in fibre-based slow-light systems via stimulated Brillouin scattering*, Electronics Letters, vol. 44, 2008, pp. 1185-1187.
- [29] SCHNEIDER, T.; HENKER, R.; LAUTERBACH, K.-U.; JUNKER, M.: *Distortion reduction in Slow Light systems based on stimulated Brillouin scattering*, Opt. Express, vol. 16, 2008, pp. 8280-8285.
- [30] WANG, S.; REN, L.; LIU, Y.; TOMOTA, Y.: *Zero-broadening SBS slow light propagation in an optical fiber using two broadband pump beams*, Opt. express, vol. 16, 2008, pp. 8067-8076.
- [31] SCHNEIDER, T.; WIATREK, A.; HENKER, R.: *Zero-broadening and pulse compression slow light in an optical fiber at high pulse delays*, Opt. Express, vol. 16, 2008, pp. 15617-15622.
- [32] BOYD, R. W.; GAUTHIER, D. J.; GAETA, A. L.; WILLNER, A. E.: *Limits on the Time Delay Induced by Slow-Light Propagation*, Proc. of QELS'05, 2005, QTuC1.
- [33] KHURGIN, J. B.: *Performance Limits of Delay Lines Based on Optical Amplifiers*, Opt. Lett., vol. 31, 2006, pp. 948-950.
- [34] SCHNEIDER, T.: *Time delay limits of stimulated-Brillouin-scattering-based slow light systems*, Opt. Letters, vol. 33, 2008, pp. 1398-1400.

Svetlana Andjelic – Slobodan Obradovic – Branislav Gacesa *

A PERFORMANCE ANALYSIS OF THE DBMS – MySQL vs PostgreSQL

Abstract: Modern communications among business subjects imply an exchange of a lot of data and information. To enhance that process in all its aspects, electronic data storing and processing is mandatory and enabled by an application of a DBMS (Date Base Management System). This paper shows the performances analysis of the two most popular open source DBMSs - MySQL and PostgreSQL. First, some characteristics of these DBMSs are shortly described. Then the applied procedure of the performed testing is described. That is, the query (select, insert, delete and order by) execution times were measured for the both DBMSs mentioned, and the results shown in tabular and graphical forms. The goal of this paper is to make the choice of an adequate DBMS easier for future users.

Key words: open source DBMS, MySQL, PostgreSQL, ACID

1. Introduction

Nowadays, it is virtually impossible to imagine the functioning of a larger system without some sort of electronic data storage. DBMS is certainly the most often used data management and permanent storage system.

It is interesting to note that the United Nations (UN) have recommended to their members to use the open source software, especially in the areas of health protection, education and international commerce. According to UN, open source software is the most adequate means for the development of their members.

In the paper, some of the basic characteristics of the most often used open source DBMS - MySQL and PostgreSQL - are described first. Second, more important part of this paper is dedicated to the description of the testing performed on those DBMS and the exposition of the results obtained.

2. The basic characteristics of the DBMS - MySQL & PostgreSQL

2.1. MySQL

MySQL is an open source database management system, conceived and implemented to rival the MS SQL. It reaches that aim to a degree, especially so when less voluminous and simpler tasks are considered.

MySQL is renowned for its speed and reliability. That's why it's one of the most popular database management systems on the web. Of the data base access technologies, there exist drivers for ODBC, JDBC i OleDb, as well as libraries for C++, Delphi, Perl, Python, PHP and TCL.

The biggest downside to this system is not checking of the referential integrity. External keys are supported by syntax, which can be misleading, because they are not actually applied. The current version neither supports views, nested queries nor stored procedures.

The run-time environment for PHP MySQL contains two significant flaws, which enable abusers to take control of the server through the memory_limit function, thus circumventing the security mechanisms in the strip_tags function. In the meantime, PHP group has announced its first final environment version of generation 5.0. The most important new features are the building-in of the Zend Engine II library with a new object model, revamped support for XML based on libxml2 library, built-in support for SOAP and the new MySQLi add-on for working with version 4.1 of the MySQL server. The latest versions are MySQL 5.1 through 5.1.21-beta and MySQL 6.0 Falcon. Falcon has been specially developed for systems that are able to support larger memory architectures and multi-threaded or multi-core CPU environments.

2.2. PostgreSQL

PostgreSQL is an object-relational database management system (ORDBMS), based on POSTGRES version 4.2.1 developed in the University of California Computer Sciences Department at Berkeley.

The first demo version became operative in 1987. Berkeley's POSTGRES was officially completed with version 4.2. In 1994, Andrew Yu and Jolly Chen implemented the POSTGRES interpreter for SQL. Under its new name, Postgres95, it was published on the web as an open-source version of the original POSTGRES Berkeley code in 1996. It supports a large part of the SQL standard and provides for many modern characteristics: complex queries,

* Svetlana Andjelic¹, Slobodan Obradovic², Branislav Gacesa³

¹The Railway College of Vocational Studies, Belgrade, Serbia, E-mail: angeo@verat.net or svetangela@gmail.com

²Megatrend University, Belgrade, Serbia

³Telekom Srpske A. D., SRJ Internet Srpske, Banja Luka, Bosna and Herzegovina

external keys, triggers, views and transactional integrity. Newer versions are 8.1 & 8.2, and 8.2.4 is the latest.

PostgreSQL has native programming interfaces for C/C++, Java, .Net, Perl, Python, Ruby, Tcl, ODBC, among others, and exceptional documentation. PostgreSQL supports international character sets, multibyte character encodings, Unicode, and is locale-aware for sorting, case-sensitivity, and formatting. PostgreSQL runs on all major operating systems, including Linux, UNIX (AIX, BSD, HP-UX, SGI IRIX, Mac OS X, Solaris, Tru64), and Windows. PostgreSQL is fully ACID compliant, has full support for foreign keys, joins, views, triggers, and stored procedures (in multiple languages).

Although not the fastest, the PostgreSQL database has been characterised as the most advanced on many tests. Inspired by Oracle, from the very beginning it supported transactions, triggers, referential integrity and matched procedures (in contrast to the MySQL). The recommendations for its use refer more to the proven quality and robustness than to the performances themselves. Among others, PostgreSQL users include UNICEF, Cisco and American Chemical Society.

2.3. MySQL vs PostgreSQL

The next table (Table 1) contains comparative data among two most popular “Open Source” database today (MySQL and PostgreSQL).

3. Test procedure

The benchmark itself consists of following steps and procedures:

- generates a set of alerts;
- connects to databases;
- creates tables inserts data;
- perform SELECT operations;
- deletes all data from the table;

When creating, adding to, editing and deleting data from the base (SELECT, INSERT, ORDER and DELETE), the system sends various warnings that trigger certain processes. In Figure 1 these processes are shown for both MySQL versions, as well as for the PostgreSQL database. The diagram was made according to the four different types of tables in bases, including the fsync PSQL option.

4. Hardware and software characteristics

Tests were performed using Intel SR2200, Xeon 2.4 GHz with 1 Gb RAM. The software was:

- operating system - Gentoo Linux 2006.1 with Linux 2.6.14 kernel,
- databases:

MySQL vs PostgreSQL [1]

Table 1

	PostgreSQL 8.0	MySQL 4.1	MySQL 5.0
Operating System	Windows, Linux, all BSDs, HP-UX, AIX, OS X, Unixware, Netware...	Linux, Windows, FreeBSD, MacOS X, Solaris, HP UX, AIX, and other	Linux, Windows, FreeBSD, MacOS X, Solaris, HP UX, AIX, and other
ANSI SQL compliance	ANSI-SQL 92/99	Possible	Possible
Sub-selects	Yes	Yes	Yes
Transactions	Yes	Yes InnoDB tables	Yes
Database replication	Yes	Yes	Yes
Foreign key support	Yes	Yes InnoDB tables	Yes
Views	Yes	No	Yes
Stored procedures	Yes (pl/SQL)	No	Yes
Triggers	Yes	No	Yes
Unions	Yes	Yes	Yes
Full joins	Yes	No	No
Constraints	Yes	No	No
Cursors	Yes	No	Partial
Procedural languages	Yes	No	Yes
Vacuum	Yes	Yes	Yes
Different table types	No	Yes	Yes
ODBC	Yes	Yes	Yes
JDBC	Yes	Yes	Yes
Other APIs	Most of languages	Most of languages	Most of languages
IPv6 support	Yes	No	No

- PostgreSQL 8.0.1
- MySQL 4.1.9
- snort 1.8 (DB v100-103)
- ACID 0.9.6b10

Alert sets were generated using open source “Nmap” and “NessusD” vulnerability scanners and tools.

In computer science, ACID (*Atomicity, Consistency, Isolation, Durability*) is a set of properties that guarantee that database transactions are processed reliably. In the context of databases, a single logical operation on the data is called a transaction. [1]

- *Atomicity* - refers to the ability of the DBMS to guarantee that either all of the tasks of a transaction are performed or none of them are. For example, the transfer of funds can be completed or it can fail for a multitude of reasons, but atomicity guarantees that one account won't be debited if the other is not credited.
- *Consistency* - property ensures that the database remains in a consistent state before the start of the transaction and after the transaction is over (whether successful or not).

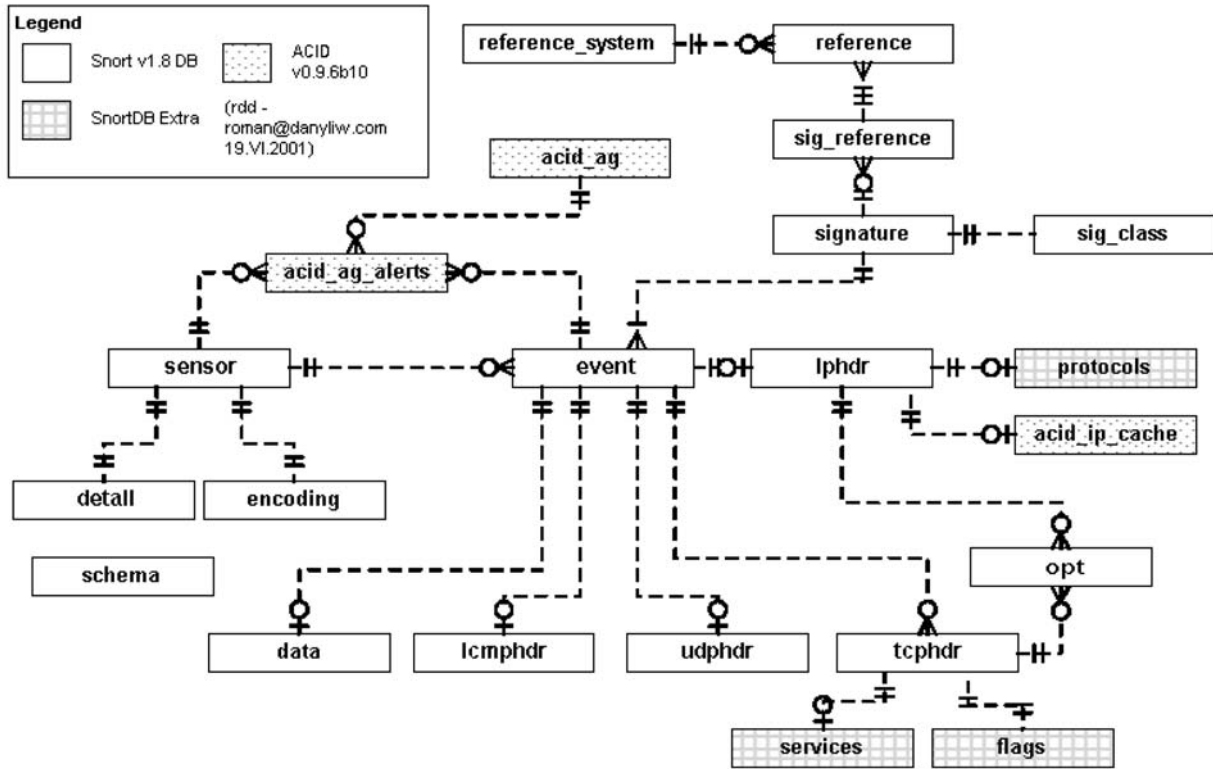

Fig. 1. Logical Database diagram - snort 1.8 (DB v100-103) and ACID 0.9.6b10 [1]

- *Isolation* - refers to the ability of the application to make operations in a transaction appear isolated from all other operations. This means that no operation outside the transaction can ever see the data in an intermediate state; for example, a bank manager can see the transferred funds on one account or the other, but never on both—even if he ran his query while the transfer was still being processed.
- *Durability* - refers to the guarantee that once the user has been notified of success, the transaction will persist, and not be undone. This means it will survive system failure, and that the database system has checked the integrity constraints and won't need to abort the transaction.

5. Test results

The results which follow were obtained by direct measuring, and obeying the previously described test procedure.

5.1. INSERT clause

Inserting pregenerated set of 50000 records to both MyISAM and InnoDB MySQL table types and PostgreSQL with fsck enabled and disabled (commit after each insert)

Table 2 shows timed results while executing "INSERT" statement against four different MySQL and PostgreSQL database table.

Tabular display of the time needed for execution of the INSERT clause

Table 2

INSERT	MyISAM-v4	InnoDB-v4	MyISAM-v5	InnoDB-v5	PostgreSQL fsync=true	PostgreSQL fsync=false
5000	3006	34745	1674	42897	17540	4825
10000	4967	71402	2235	85964	14052	8772
15000	7474	103469	3525	128697	21873	13064
20000	9996	143009	4739	168609	110359	17374
25000	12524	170862	5897	212718	101442	21974
30000	15034	186316	6996	261772	51390	26148
35000	17515	119604	8266	297953	49103	30484
40000	20040	58373	9512	337577	158071	35112

The following graph (Graph 1) contains a graphical display of the results shown in Table 2. X-axis shows the number of records, while y-axis depicts time in milliseconds.

5.2. SELECT clause

Inserting pregenerated set of 50000 records to both MyISAM and InnoDB MySQL table types and PostgreSQL with fsck enabled and disabled (commit after each insert)

Table 3 shows timed results while executing “SELECT” statement against four different MySQL and PostgreSQL database table.

The following graph (Graph 3) shows timed results while executing “ORDER BY” statement against four different MySQL and PostgreSQL database table. X-axis shows the number of records, while y-axis depicts time in milliseconds.

5.4. DELETE clause

Inserting pregenerated set of 50000 records to both MyISAM and InnoDB MySQL table types and PostgreSQL with fsck enabled and disabled (commit after each insert).

Table 4 shows timed results while executing “DELETE” statement against four different MySQL and PostgreSQL database table.

Tabular display of the time needed for execution of the SELECT clause

Table 3

SELECT	MyISAM-v4	InnoDB-v4	MyISAM-v5	InnoDB-v5	PgSQL fsync=true	PgSQL fsync=false
5000	45	42	44	34	108	104
10000	157	174	71	66	141	150
15000	110	113	114	122	218	219
20000	240	156	248	182	429	300
25000	288	303	201	193	420	506
30000	352	251	235	375	489	614
35000	378	285	262	286	721	738
40000	415	316	293	347	864	805



Graph 1. INSERT clause

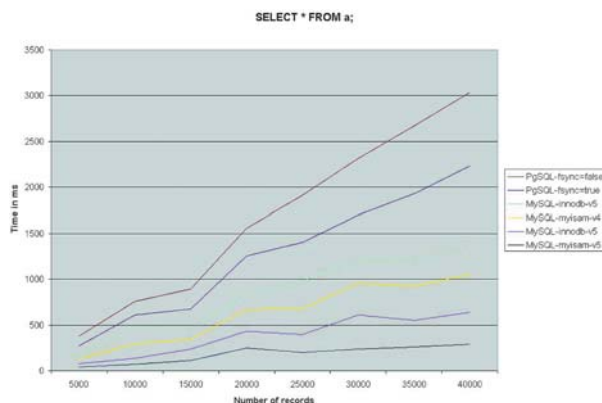

Graph 2. SELECT clause

The following graph (Graph 2) contains a graphical display of the results shown in Table 3. X-axis shows the number of records, while y-axis depicts time in milliseconds.

5.3. ORDER BY clause

Inserting pregenerated set of 50000 records to both MyISAM and InnoDB MySQL table types and PostgreSQL with fsck enabled and disabled (commit after each insert)

The following graph (Graph 4) contains a graphical display of the results shown in Table 4. X-axis shows the number of records, while y-axis depicts time in milliseconds.

6. Conclusion

Modern communications among business subjects imply exchange of a lot of data and information. To enhance that process

Tabular display of the time needed for execution of the DELETE clause

Table 4

DELETE	MyISAM-v4	InnoDB-v4	MyISAM-v5	InnoDB-v5	PgSQL fsync=true	PgSQL fsync=false
5000	1	78	1	4	23	19
10000	2	166	2	8	56	40
15000	3	259	3	11	79	60
20000	3	330	3	15	104	82
25000	3	370	4	19	216	150
30000	4	405	4	21	220	151
35000	4	490	4	25	230	241
40000	5	664	6	28	341	235

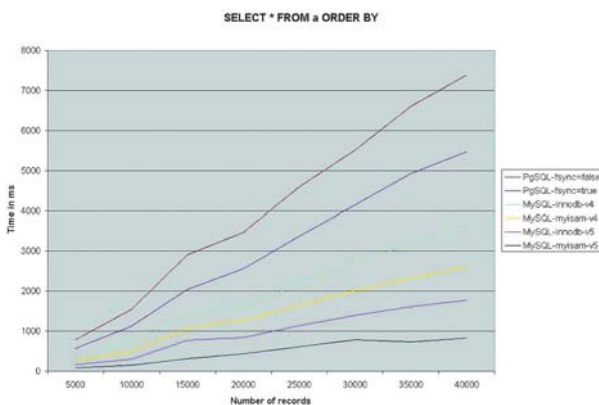

Graph 3. ORDER BY clause

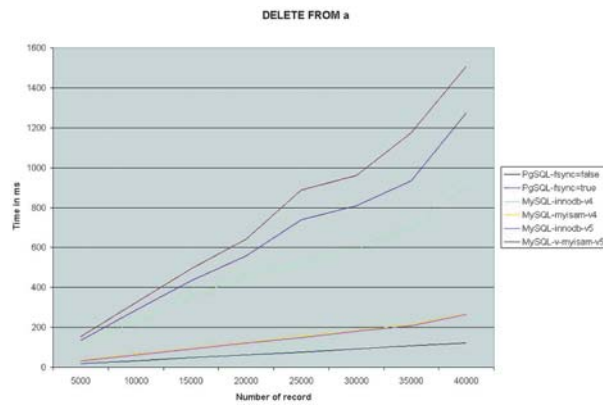

Graph 4. DELETE clause

an electronic data storing and processing is mandatory and enabled by the application of a DBMS.

From the test results shown one concludes that the MySQL/MyISAM DBMS performs better than the PostgreSQL.

In the case where, regardless of the integrity of data, the speed of query execution is important, one should choose MySQL. Contrarywise, PostgreSQL provides greater consistency and smaller robustness of the base as well as greater security from the system failure.

The general conclusion cannot be reached, but depending on the type of the server and types of clients to access the base, some

recommendations can be given. If both the server and the clients are Linux (and transactions are needed), Postgres is recommended. In the case of Linux/Unix server and Windows clients, then Oracle certainly is recommended, since ODBC support for MySQL is bad, and nonexistent for PostgreSQL.

Before choosing one of the DBMSs, the criteria relevant to the problem should be laid down.

It is to be presumed that the performances of MySQL and PostgreSQL will converge in the future, aiming to create a fast, secure and optimally robust DBMS.

References

[1] ANDJELIC, S., OBRADOVIC, S., GACESA, B.: *A Performance Analysis of the Open Source Database*, XIII conference YUINFO 2007, Kopaonik, Serbia, ISBN 978-86-85525-02-5

[2] KLINE, K. E., KLINE, D., HUNT, B.: *SQL in Nutshell*, O'Reilly, 2004

[3] WORSLEY, J. C., DRAKE, J. D.: *Practical PostgreSQL*, O'Reilly, 2002

[4] RUSSELL, J. DYER, T.: *MySQL In A Nutshell*, O'Reilly, 2005

[5] HORN, J. W., GREY, M.: *MySQL: Essential Skills*, McGraw-Hill Professional, 2004

[6] http://support.summersault.com/why_postgresql.html

[7] <http://www.postgresql.org>

[8] <http://www.mysql.com>

INVESTIGATION OF SOME ISSUES OF FULL OPTICAL MULTIMEDIA NETWORKS

Deployment of optical communication technologies into the core networks has allowed improvements in the transmission characteristics. Further penetration towards the end-user customers has brought online multimedia services. Increasing demand for a quality of service and new types of multimedia services challenges current state of the art technologies and drives not only coming technological trends. Recently emerging DPSK (Differential Phase Shift Keying) format is described and impact of OSNR (Optical Signal to Noise Ratio) level and laser linewidth on its performance is investigated in the environment of Virtual Photonics simulation software. Behavior of used modulation format within WDM (Wavelength-Division Multiplexing) system is examined at four channel's WDM system.

1. Introduction

A progress in information and communication technologies has allowed high bit rates being affordable to mass market. Multimedia services has got infrastructure with sufficient performance and they could reach their target customers. The expansion of multimedia services and decreasing cost for transmitted megabytes are synergic driving forces. The demand for higher transmission capacity and higher efficiency pushes optical communication to create more complex designs and solutions. In this process, a lot of various effects occur. Optimal setting is a trade-off between introduced distortions due to phenomena and their relations in the optical fibre and our capabilities to suppress them. The possibility of pure physical experiments is unacceptable from more points of views. The response is the application of simulation methods as one part of developing and implementation process. The simulation accuracy and depends from simulation models and assumptions.

Current demand for longer distances and higher bit rates per channel are met by a replacement of primary used on-off keying (OOK) by differential phase shift keying (DPSK) due to its higher sensitivity and robustness against nonlinear effects [1, 2, 3]. Theoretical knowledge was summarized by Gnauck et al. [4]. We wish to deeper investigate DPSK behavior, particularly impact of the laser linewidth and nonlinear effects in the presence of more optical signals with different wavelengths and simulate wavelength division multiplexing system. Our work is carried out in simulation environment of VPI Virtual Photonics.

Second chapter briefly introduces a differential phase shift keying (DPSK) format. Third chapter will show performed simulations and their results. Results are summarized and discussed in conclusion.

2. Differential phase shift keying

Phase-shift-keyed (PSK) formats carry the information in the optical phase itself. The receiver has to compare detected signal with reference signal and extract information. Due to the lack of an absolute phase reference in direct-detection receivers, the phase of the preceding bit is used as a relative phase reference for demodulation. This results in DPSK formats, which carry the information in optical phase changes between bits. DPSK has got several advantages against ASK (Amplitude Shift Keying) modulation thus it is not surprising that many of the recent long-haul WDM transmission records at per-channel rates of 10 and 40 Gb/s are now held by systems based on DPSK.

Optical systems based on DPSK are not new. DPSK was extensively studied in the late 1980s and early 1990s for use mainly in single-span fiber-optic systems employing coherent receivers as well as in the context of free-space optical communications, where the 3-dB sensitivity advantage over OOK could be exploited. When erbium-doped fiber amplifiers (EDFAs) were introduced, interest in coherent systems declined. For about a decade, OOK-based WDM systems using optical-amplifier repeaters dominated the research in long-haul optical communications. Interest in DPSK reemerged several years ago, as WDM systems were pushed to ever-higher levels of performance [4].

In the DPSK format, optical power appears in each bit slot, with the binary data encoded as either a 0 or π optical phase shift between adjacent bits. The optical power in each bit can occupy the entire bit slot (NRZ-DPSK) or can appear as an optical pulse (RZ-DPSK). The most obvious benefit of DPSK when compared to OOK is the ~ 3 -dB lower OSNR required to reach a given BER. This can be understood by comparing the signal constellations for DPSK and OOK, as shown in Fig. 1. For the same

* Dusan Sabol¹, Jozef Dubovan², Miroslav Markovic², Milan Dado²

¹Dept. of Electrical, Electronical and Mechanical Engineering, University College Dublin, Ireland, E-mail: dsabol@centrum.sk

²Dept. of Telecommunications and Multimedia, FEE, University of Zilina, Slovakia,

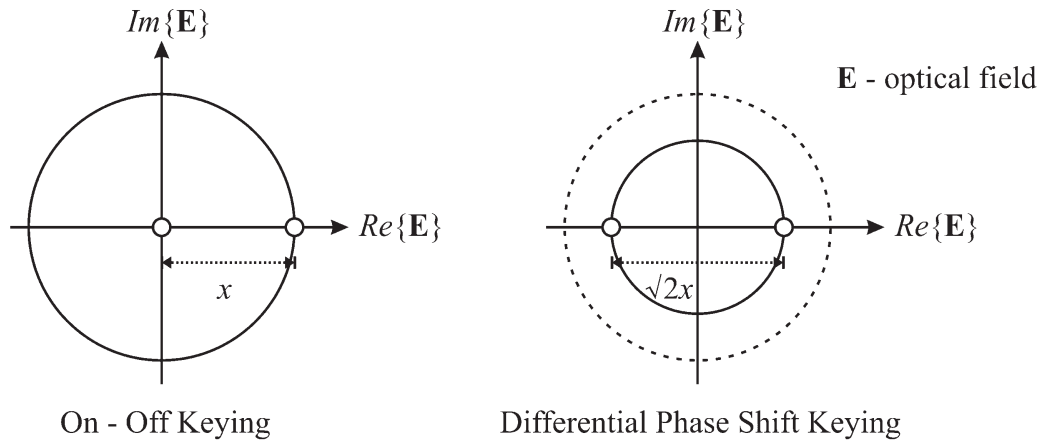

Fig. 1 Signal constellation of OOK and DPSK modulation [4]

average optical power, the symbol distance in DPSK (expressed in terms of the optical field) is increased by $\sqrt{2}$. Therefore, only half the average optical power should be needed for DPSK as compared to OOK to achieve the same symbol distance. This ~ 3 dB benefit of DPSK modulation can be only extracted by using balanced detection [4].

The lower OSNR requirement of DPSK can be used to extend transmission distance, reduce optical power requirements or relax component specifications.

DPSK with balanced detection has been demonstrated to offer large tolerance to signal power fluctuations in the receiver decision circuit because the decision threshold is independent of the input power. DPSK is more robust to narrow-band optical filtering than OOK, especially when balanced detection is employed. Numerical simulations and experiments have shown DPSK to be more resilient than OOK to some nonlinear effects. This results from the fact that: i) the optical power is more evenly distributed than in OOK (power is present in every bit slot for DPSK, which reduces bit-pattern-dependent nonlinear effects) and ii) the optical peak power is 3 dB lower for DPSK than for OOK for the same average optical power. Finally, an extension to differential quadrature phase-shift keying (DQPSK) and other multilevel formats should enable higher spectral efficiency and greater tolerance to chromatic- and polarization-mode dispersion [5].

In the next section, we come to simulations. In First step we want to reproduce experimentally obtained results achieved by Avlonitis et al [5] that our simulation environment will be in agreement with their results. Then we proceed in our simulation, add some WDM network components and examine the impact of the laser linewidth and Kerr's effect on the DPSK signal propagation in 4 channel WDM system.

4. Simulation

All simulation work was carried out in the simulation environment of VPI Photonics, which allows various conditions and assumptions. In order to get realistic data, we take a work of Avlonitis et al. [5] and try to get the same results from simulation. They looked on the effect of various values of OSNR and the laser linewidth on the narrowband filtered DQPSK modulation format on BER in the back-to-back configuration. They explore BER as a function of OSNR for different laser linewidth. Their equivalent scheme in VPI Photonics environment is shown in Fig. 2.

NRZ-DQPSK source consists of CW laser followed by two dual stage Mach-Zehnder modulators. The used bit rate was 10 Gb/s. The source output power and power density of AWGN (Additive White Gaussian Noise) was set on the values that corresponded to OSNR = 5 dB. The attenuator modified level of OSNR in the

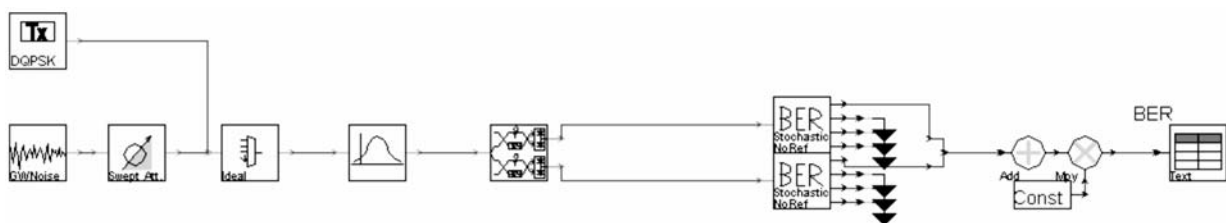

Fig. 2 Simulation scheme of BER = f(OSNR) for DQPSK filtered signal in back-to-back configuration [6]

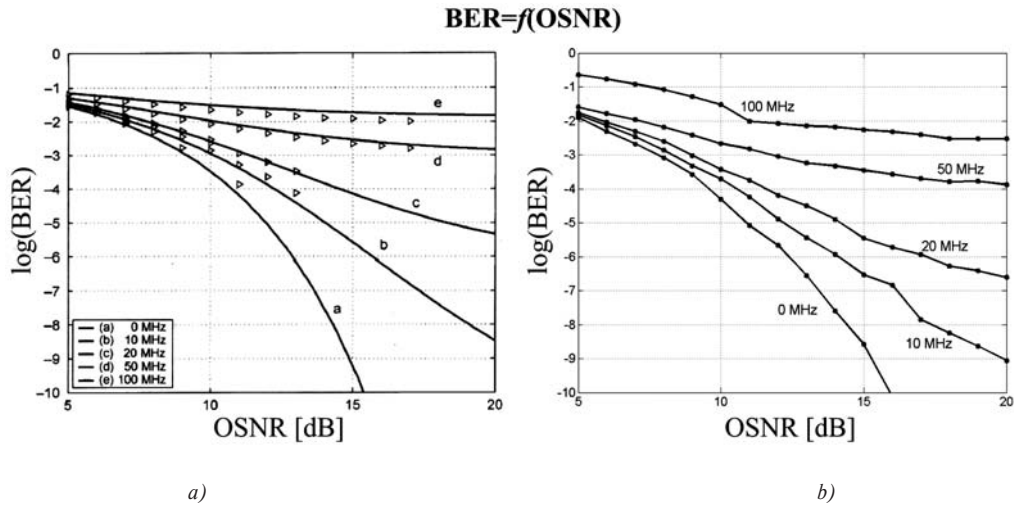

Fig. 3 a) experimental and b) simulation results

range from 5 to 20 dB. The signal passed through 1st order Gaussian bandpass filter with 6 GHz linewidth (spectral efficiency equals to 1.67 b/s/Hz), which was identical with the experiment. The signal was demodulated in the optical delay line demodulator and detected at the balanced receiver. At the end, BER was assigned to every value of OSNR. It was done for 0, 10, 20, 50 and 100 MHz laser linewidth. Both experimental and simulation results are plotted in Fig. 3.

Next step involved the increase of the bit rate up to 40 Gb/s and filter bandwidth expansion up to the equal value of spectral efficiency. Unfortunately, the simulation provided satisfied results only up to 15 dB or $BER = 10^{-4}$, which was not sufficient. The

40 Gb/s bit rate variant was not estimated with a desired likelihood and will not be considered in further simulation.

Another simulation investigated DPSK modulation. The setup was modified by replacing DQSK (Differential Quadrature Shift Keying) components for DPSK components. DPSK source consisted of a CW (Continuous-Wave) laser and one dual stage Mach-Zehnder modulator. Laser power was set on one half of the previous value and bandpass filter had a half bandwidth in order to keep the same effect of a filter on the modulated signal. One delay line interferometer with a single balanced receiver was employed and BER (Bit Error Ratio) estimation provided the same module (Fig. 4).

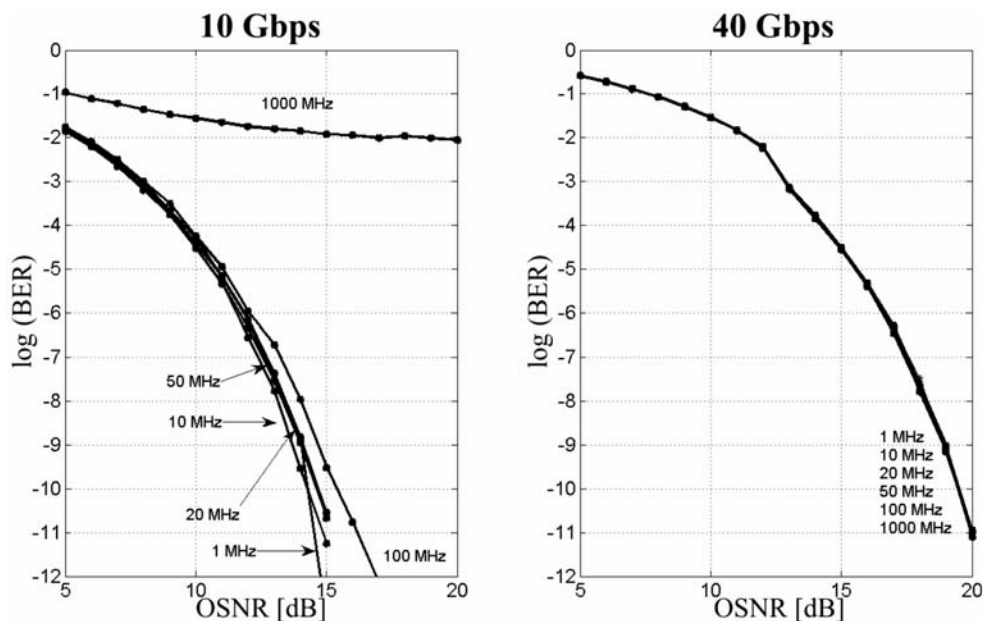

Fig. 4 BER vs OSNR for 10 Gbps and 40 Gbps DPSK format

The transmission bit rate was 10 Gb/s. The output data corresponds to theoretical predictions that DPSK is more resistant against phase noise. The divergence of particular curves is not rapid, but a typical flat waveform occurs for 1 GHz linewidth. The OSNR difference between DQPSK and DPSK shows better performance of DPSK. Its benefit increases with lower BER. The DPSK source generated 40 Gb/s stream didn't repeat the specific behavior of coherent systems with phase noise. The simulation at 40 Gb/s DPSK might not give us physically reasonable results hence 40 Gb/s bit rate will not be simulated.

We choose 10 Gb/s data stream in NRZ-DPSK format generated by two different lasers with 2 MHz and 500 kHz linewidth and lase them into the optical fibre. We do the same also for NRZ-OOK format.

5. OOK and DPSK performance in the fibre

In this section, the optical link is connected to four DPSK transmitters and we wish to see an effect of fibre (especially non-linear effects occurring in WDM systems) on the signal. The transmitter and receiver parameters are identical with previous simulations. Channel spacing is set on 50 GHz. The optical fibre is arranged in the 4 km long fibre loop. Dispersion compensating fibre (DCF) is inserted between transmission fibre, which is non-zero dispersion shifted fibre (NZ-DSF) and measurement devices. Demultiplexing provides the identical filter like in the previous simulations. We monitor optical spectrum, eye diagrams of signal's channels, power levels of selected signal channels and two lower, two upper induced bands [6] (simulation scheme is depicted in the Fig. 5).

OOK format is not sensitive to the used laser linewidth. On other hand, DPSK format performance is dependent on the linewidth of used laser and narrowed linewidth shows better performance. Our comparison shows a case of 500 kHz laser linewidth.

The eye diagrams of signal before the entering of fibre scan are shown in Fig. 6. We notice a large eye opening in both cases. OOK and DPSK format might be distinguished by a time jitter. If we increase a laser linewidth, OOK will have negligible distortion but borders defining an area of DPSK eye diagram (red lines in Fig. 6) will get broader and therefore caused the closing of eye.

We sent the laser output through fibre and wanted to monitor a signal distortion span-by-span, which gives us a 6 km interval. Unfortunately, VPI Photonics was not able to calculate BER and show proper results of second and higher fibre spans.

Our evaluation is based on the eye diagram comparison. OOK format eye diagrams of all 4 channels are shown in Fig. 7 (left) and the same graphs for DPSK format are in Fig. 7 (right). We might notice a different character of distortion, where OOK format has a lot of amplitude noise in the high level. A noise power after 4 km transmission through fibre is few orders higher opposite the back-to-back signal. DPSK format after 4 km fibre propagation is almost unaltered. Both eye diagrams have approximately the same value of opening after the 4 km fibre span. If we return back to back-to-back setup, Fig. 6, we will see that OOK format has got advantage of ~2.5 mW higher value (~8 mW for OOK against 5.5 mW for DPSK) compared to DPSK format.

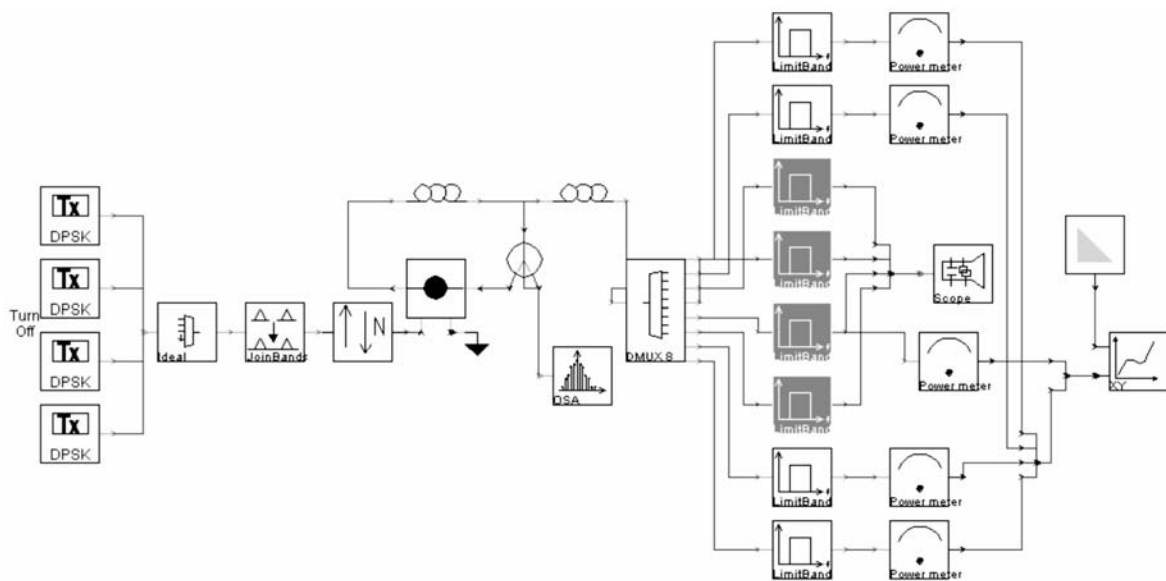

Fig. 5 Simulation scheme of FWM generation

Eye diagram

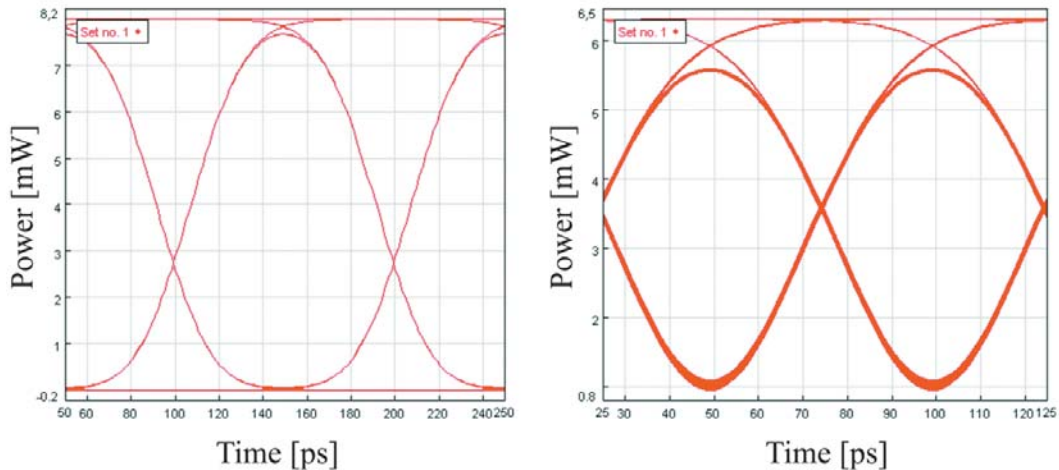

Fig. 6 Eye diagrams of OOK (left) and DPSK (right) transmitters. Laser linewidth 500 kHz

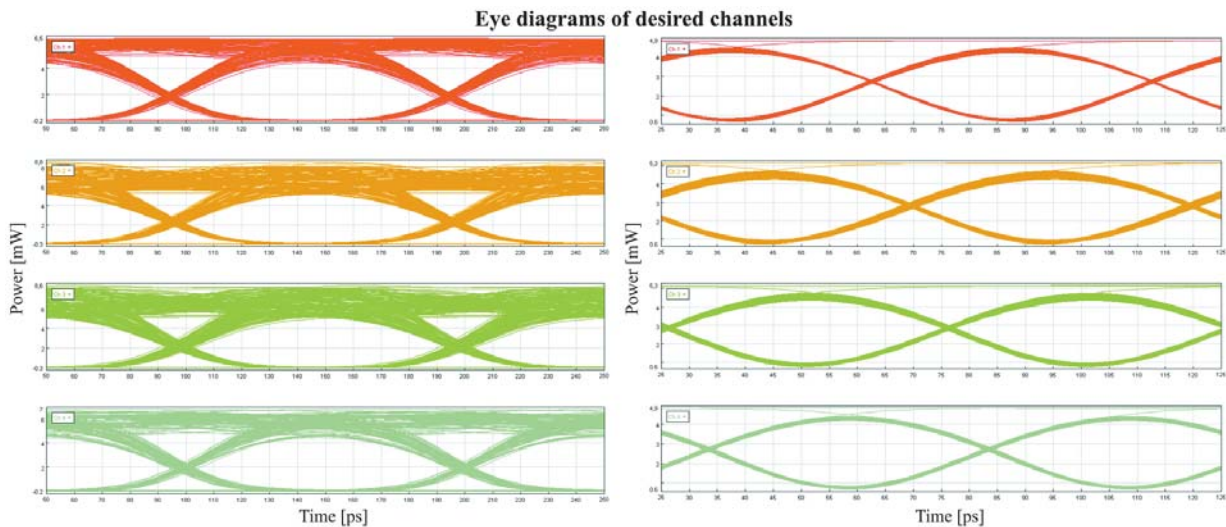

Fig. 7 Eye diagrams after 6 km span, OOK format(left), and eye diagrams after 6 km span, DPSK format (right)

Fig. 7 Eye diagrams after 6 km span, OOK format(left), and eye diagrams after 6 km span, DPSK format (right)

An excess power of 2.5 mW has been converted to the noise, which is distributed around the 5 mW value. It might suggest that DPSK is more resilient against nonlinear processes than OOK. Nonlinear effects are significant at high powers, which means, in the beginning of spans or after amplifiers. Another advantage of DPSK format is in using a balanced receiver which increases sensitivity by 3 dB and hence might improve BER. But we could not make such an analysis.

6. Conclusion

Performance of DPSK and DQPSK transmitters was examined for various values of OSNR and laser linewidth for today's 10 Gb/s and future 40 Gb/s gold standard bit rates. Model deployed higher bit rate is not absolutely relevant, because it predicts unrealistic behavior for OSNR > 15 dB or BER > 10⁻⁴. The model of lower bit rate estimation operated reliably and was used for the evaluation of nonlinear effects on the DPSK and OOK modulation formats for two types of optical fibre and two laser linewidths. The simulation shows a significant noise generation in OOK

signal, which was not the case in DPSK signal. It might suggest higher DPSK resilient against nonlinear effects. DPSK showed a lower distortion and a criterion of BER could not be applied due to computation difficulties. In BER performance DPSK would also have a benefit of balanced detection and might show even better performance.

Acknowledgements

The research presented in this paper was done with the support of COST 291 action.

APVV project COST-0041-06 and APVV project "Technologies for optical signal processing for the next generation optical digital networks".

References

- [1] CHARLET, G., CORBEL, E., LAZARO, J., KLEKAMP, A., DISCHLER, R., TRAN, P., IDLER, W., MARDOYAN, H., KONCZYKOWSKA, A., JORGE, F., BIGO, S.: *WDM Transmission at 6-Tbit/s Capacity Over Transatlantic Distance*, Using 42.7-Gb/s Differential Phase-Shift Keying Without Pulse Carver, *Journal of Lightwave Technology*, 1/2005.
- [2] YOSHIKANE, N., MORITA, I.: *1.14 b/s/Hz Spectrally Efficient 50 85.4-Gb/s Transmission Over 300 km Using Copolarized RZ-DQPSK Signals*, *Journal of Lightwave Technology*, 1/2005, pp. 108-114.
- [3] BIGO, S.: *Optimizing terrestrial systems for 40 Gbit/s channel bit rates*, Glasgow: ECOC 2005.
- [4] GNAUCK, A. H., WINZER, P. J.: *Optical PSK transmission*, *Journal of Lightwave Technology*, 1/2005.
- [5] AVLONITIS, N. S., YEATMAN, E. M.: *Performance Evaluation of Optical DQPSK Using Saddle Point Approximation*, *Journal of Lightwave Technology*, 3/2006
- [6] SABOL, D.: *WDM systems with DPSK keying*, *Diploma thesis*, University of Zilina, 2006.

P. Mandl – P. Schrotter – E. Leitgeb *

OPTICAL, WIRED AND WIRELESS MULTIMEDIA SERVICE ACCESS SOLUTIONS FOR TREND SETTING REAL ESTATES

It is a well known fact that the value of real estates is raised tremendously by its connection to information technology services like Voice over IP (VoIP), IPTV, Video on Demand (VoD), basic Internet services and house-, security- and surveillance technologies. This paper will focus on different state of art methods to connect a real estate to the above mentioned services and will also discuss various inhouse cabling systems and related devices. Advantages and disadvantages between the miscellaneous combinations will be discussed.

Keywords: FSO, multimedia, broadband Internet, optical networks, VoIP, IPTV, videoconferencing

1. Introduction

In the next decades the economic future will lead Europe in a position to be more and more a supplier of services than of commodities. Because of cheap manufacturing costs imports are done from other low wage countries (e.g. China). The production of goods in Europe will get more and more expensive, the customers and the market will choose cheaper imports. This is a harmful evolution for the European economy. Therefore effective strategies have to be evolved to be competitive. At least Europe has to be a global provider for engineering, intellectual and other high quality services. Taking into account the latter enumerated services the future good will be the high quality global communication and information exchange.

Right now there is already a strong trend and demand for interactive social networks, like Internet TV, online communities, new services and forms of interactive living (video-conferencing). A current example of emerging services is the interactive ubiquitous and convergent Grand Media Internet TV portal. This portal enables its users to upload and broadcast content to their specific audiences, allows multimedia e-commerce and communication services via the Internet and supports with mobile user end devices. An additional set top box offers these services also for widespread classic TV sets [1]. A very promising future demand will be the combination of such platforms with house-, security- and surveillance services.

However, all these services require guaranteed synchronous broadband Internet services. In entire Europe the performance of the last mile access usually does not satisfy this future demand. Telecommunication companies use their outdated copper networks and are not interested to invest into next generation fiber networks. Especially in Austria there is the common situation that WIMAX frequency licenses auctioned by the local telecommunication regulator are held and not used by monopolistic telecommunication

providers. The possible reasons for this attitude are doubtful and also hostile to innovation.

Current trends show that the volume of the Internet traffic until 2012 will be multiplied by the factor of 6 due to the emerging field of online videos.

In Austria there have been initiatives by the local governments to provide the population with so called broadband Internet based on copper lines. In reality the broadband initiatives provide asynchronous lines with 0.3 Mbit/s upload and 1 Mbit/s download. The International Telecommunication Union (ITU-T) standardization recommendation I.113 has defined broadband as a transmission capacity that is more than 1.5 to 2 Mbit/s [2].

Because of this unsatisfying situation and the lack of reasonable fiber optic infrastructure which is not provided by monopolistic telecommunication companies, this paper will concentrate on alternative last mile access technologies to real estates to satisfy the future broadband demand. Especially local and regional communities, societies and service providers could be a veritable concurrency with their local networks.

These technologies will provide companies, societies and citizens with genuine broadband services, also environmental and economic factors like global warming and CO₂ issues can be improved.

When we are talking about real estates in the following sections, we basically reckon buildings within a settlement or residential with a reasonable amount of units. Having just a single building, a lot of factors like central maintenance and service purchase, high flexibility, homogenous services and technologies cannot be achieved in terms of low costs. Especially these costs rise the value and the attractiveness for possible real estate investors and customers.

* P. Mandl¹, P. Schrotter², E. Leitgeb¹

¹Graz University of Technology, Institute of Broadband Communications, Graz, Austria

²Graz University of Technology, Institute of Communication Networks & Satellite Communications, Graz, Austria, E-mail: peter@mandl.org

2. Last mile broadband access technologies to real estates

In this section we will present the function of several broadband last mile access technologies and will show advantages and disadvantages. The definition of broadband Internet services in this publication will include several services like IPTV, Voice over IP (VoIP), Video on Demand (VoD) and all well known basic Internet services (e.g. email, www). These services will be based on access technologies like DSL, Fiber to the Home (FTTH), Free Space Optics (FSO), WIMAX, WLAN and Digital Video Broadcasting - Terrestrial (DVB-T) and its future variants. It is the basic idea to have one general service provider which is connected to a standardized flexible "data interface" like copper twisted pairs, coaxial cable and fibers into the real estates.

To understand the different services and to weight its "bandwidth cost", Tab. 1 shows the different average bandwidth consumption per service.

Tab.1 also significantly shows that services like VoD, IPTV and videoconferencing consume most of the bandwidth, especially with high definition content.

VoD is a technology based on unicast video streams. Each user gets an individual unicast data stream when he decides to consume a specific content. The total bandwidth is increased directly proportional to the number of unique users or video streams.

IPTV usually is provided via multicast streams and is comparable with the classic TV. The number of provided TV channels is the factor for calculating the backbone bandwidth. This has especially to be taken into account when a real estate is providing HDTV services. The data rate is a multiple of the standard definition (SD) data rate. A fix amount of the access bandwidth according to the number of provided TV channels has to be preserved for their proper function. The worst case scenario is, that all different channels are watched at the same time by all users, causing insufficient bandwidth which is not available for other services (e.g. emergency calls). This has to be avoided strictly in the planning phase.

Videoconferencing is a technology where two or more users can communicate with video and audio streams. Both users can see and hear each other at the same time which requires a synchronous data connection. Especially IPTV and videoconferencing in high definition quality consumes very much bandwidth ranging from 0.5 Mbit/s up to 12 Mbit/s depending on the purpose. In general the bandwidth of 30 Mbit/s will not be reached but in applications which requires a very high resolution (e.g. the transmission of a medical surgery), or for independent end devices.

Regarding the emerging trend of video services in the Internet, it is remarkable that most of the used Internet lines worldwide are asynchronous (e.g. ADSL, DOCSIS). Most Internet access lines do not have a guaranteed bandwidth (Committed Information Rate - CIR), which will be a future bottleneck.

2.1 DSL technologies based on copper lines

In entire Europe the DSL (Digital Subscriber Line) technology is one of the most widespread technologies for the last mile access. By using a DSLAM (Digital Subscriber Line Access Multiplexer) and a corresponding DSL modem the connection to the user is established physically. The practical experience shows these services often have a lack of bandwidth. Most copper lines which are leased by Internet service providers are outdated, sometimes the initial cable installation goes back to the 19th century. Hence the cables often are in bad shape and the connection is affected by high attenuation and connection losses at higher bit rates. Usually the copper lines have to be rent from monopolistic telecoms. The providers are basically allowed to use a gross bit rate of 2.36 Mbit/s for payload transfer with a net bit rate of 2048 Kbit/s over this copper line pair. The signals have to be defined accordingly to ETSI TS 101 524 (SDSL) and ETSI TR 101 830. It is a fact that ISP's usually do share the bandwidth for economical reasons with a number of users (overbooking). A minimum guaranteed bit rate, the Committed Information Rate (CIR) is neither offered nor desired by ISP's in most cases. For the common implementation of genuine multimedia services in real estates this access technology is just of limited applicability.

Overview of different bandwidth consumption per service

Tab. 1

Service	Bandwidth	Protocol
House-, Security technologies	0.001 - 0.1 Mbit/s	TCP(IP)
Voice over IP (VoIP)	0.01 - 0.1 Mbit/s per call	TCP(UDP)
Surveillance technologies	0.5 - 1 Mbit/s per stream	TCP/UDP(IP)
VoD	0.5 - 1 Mbit/s per stream	TCP(IP)
Basic Internet services	up to 1 Mbit/s	TCP(IP)
IPTV	0.5 to 5 Mbit/s per channel	IP Multicast
Videoconferencing	0.5 to 5 Mbit/s per channel	TCP(IP)
IPTV HD	1.5 to 12 Mbit/s per channel	IP Multicast
Videoconferencing HD	1.5 to 12 Mbit/s per channel	TCP(IP)

2.2 FTTH

Fiber To The Home (FTTH) is the most interesting technology to connect a real estate to convergent information technology services. This is based on the theoretical bandwidth of a single fiber which is just limited by the accuracy of optical filters (number of wavelengths, WDM, DWDM) and the throughput of the Ethernet switch backplanes and ports. The latter facts are characteristics for a next generation infrastructure which will be adaptable to the users needs and state of technology. Higher bandwidths can be achieved by simply changing slower with faster active network components.

In general we can divide the FTTH access methods into two main groups:

2.2.1 Direct fiber connection

This approach connects a network operation centre (NOC) directly with the user's end device with at least one single fiber. By using bidirectional data transfer mode it delivers the highest performance to the user. For such a connection two different wavelengths for the up- and downlink are used. Because of the amount of required Ethernet switches and ports, every user gets one centrally switched fiber, this solution in fact is very expensive. Every user needs at least one switch port that has to be managed and serviced which produces additional costs.

2.2.2 Passive Optical Network (PON)

The main advantage of PON is the architecture transferring data point-to-multipoint with passive optical units. Hence these

units are not required to have an electrical power supply, and no specific or additional management or maintenance is necessary.

Basically a PON consists of a network operation centre (NOC) including an optical line terminal (OLT), one or more distribution nodes (Optical Network Units, ONUs) and the fibers and splitters between them, which are called the optical distribution network (ODN).

The Passive Optical Networks did evolve from the ITU-T G.983 standard. The first realisations have been APONs (ATM Passive Optical Networks) and BPONs (Broadband PONs). Afterwards the GPON (Gigabit PON, ITU-T G.984) was the successor of the former standard which enables higher bit rates and security features. EPON or GEPON (IEEE 802.3ah) is the corresponding IEEE standard for using this technology for Ethernet data transfer.

PON uses two different wavelengths (wavelength division multiplex, WDM) for the up and downlink. Current systems can transport 2.4 Gbit/s of downstream bandwidth, and 1.2 Gbit/s of upstream bandwidth within a range of 20 km by a single fiber.

There is already a new standard, IEEE 802.3av (10GPON), which allows the use of more wavelengths enabling to higher bit rates per single fiber.

2.3 FSO - Free Space Optics

A free space optics data transfer system (FSO, Fig. 1, Fig. 2) is a very flexible broadband access solution offering high data rates without long cabling for the mobile access to backbone networks [3,4,5,6]. In difference to other mobile data transfer methods (e.g. point-to-point radio systems) a FSO system has outstanding



Fig. 1 FSO Unit



Fig. 2 FSO unit mounted on a roof, detail front view

advantages like higher bandwidth, better ability to concentrate beams, simpler assembling and disassembling, better beam bundling, no license fees for the usage of radio channels, better security against wiretapping and also better environmental compatibility (no electromagnetic pollution). Disadvantages are atmospheric influences like rain, snow, fog and direct sun beams.

Today FSO systems are used for the quick setup of low range inner city links (point-to-point), broadband links over motorways, rail tracks or over rivers as well as for the wiretap-proof connection between company buildings and corresponding institutions. Further applications could comprise the connection of mobile emergency response services and other equipment of executive authorities, the fire brigade, and armed forces to a backbone network during crisis operations. For these reasons FSO is the ideal technology to operate within the above mentioned cases and many more scenarios. A FSO system which offers a bidirectional point-to-point connection consists of two separated OSE's (optical sending and receiving unit) with integrated receiving (PIN diodes) and transmitting devices (laser diodes). Typical FSO data rates range from 100 Mbit/s up to 1.5 Gbit/s.

According to standardized laser classes the output power is restricted for health safety measures [7]. The typical fog attenuation in Austrian regions, the main limitation for an FSO link, is specifically about 100 dB/km. To overcome this, the laser power can be increased up to more than 500 mW (laser class 4B) which can cause eye damages. Hence the position of the OSE's has to be selected carefully to reduce the possibility of health damages.

FSO systems on sea vessels with auto tracking units have been reported to bridge 25 km offering a data rate of up to 1.5 Gbit/s by using up to 7500 mW of laser power [12]. The nomadic use of a FSO system with multimedia applications using 100 Mbit/s over 1.2 km have already successfully been demonstrated [8, 9, 11]. Within a settlement or a group of real estates FSO is a very effective

solution to interconnect buildings without additional excavation.

2.4 WIMAX

WIMAX (Worldwide Interoperability for Microwave Access) is a technology that provides wireless data via radio frequency point-to-point or point-to-multipoint links and also enables full mobile cellular type access. WIMAX is based on the IEEE 802.16 standard and the frequency use is license based.

The licences usually are auctioned by the local governments or telecommunication regulators. WIMAX is a very interesting technology regarding the output power of up to 4.5 kW ERP and a synchronous bandwidth of 100 Mbit/s per base station which enables an operating range of up to 20 km. The user's connection to a WIMAX base station is established with a simple end device and an appropriate antenna installation.

We already mentioned, in Austria all WIMAX licenses are owned by those who currently do not use or rent these frequencies. The current situation inhibits the use of this interesting technology.

2.5 WLAN

WLAN IEEE 802.11a, b, g, n is a widely used technology for wireless network connections. Public frequencies are free to use for everybody within the allowed transmission power (EIRP) for the specific frequency range (Fig. 3).

Depending on the standard there are two frequencies used, 2.4 and 5 GHz. Regarding the free space loss and the allowed EIRP it has been shown that the 5 GHz band is better suited for

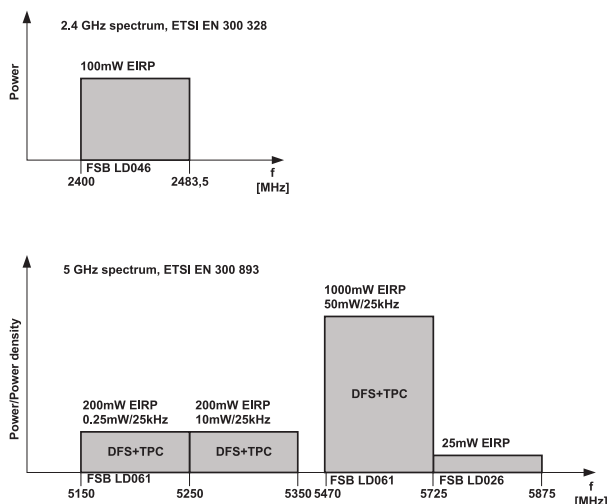

Fig. 3 License exempt frequency spectrums according to ETSI

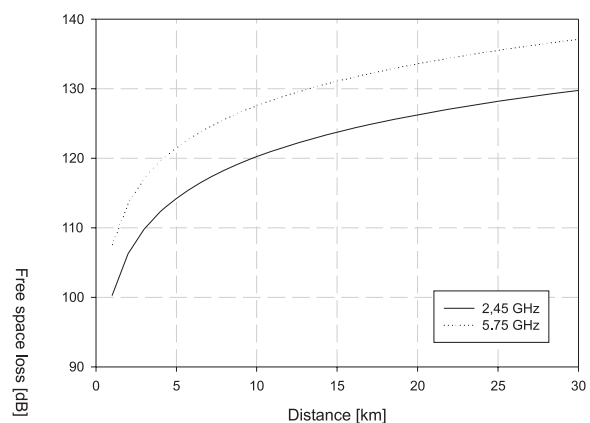

Fig. 4 Comparison between free space losses of 2.4 and 5 GHz

long range connections with directed radio antennas between two WLAN transceivers (Fig. 4).

By calculating the link budget for the 5 GHz band within the allowed EIRP there is a link margin of 11 dB for a link length of 5-10 km [10]. With such a link it is possible to provide a bandwidth of net 60-90 Mbit/s in line of sight situations.

2.6 DVB-T with WLAN backchannel

Digital Video Broadcasting - Terrestrial (DVB-T) is a relatively new technology for transmitting digital data in a specific local region. It transmits a compressed video/audio stream using the OFDM modulation. For the compression of the data usually the MPEG2 or H264 algorithm is used. Usually DVB-T is used for broadcasting digital TV channels. A DVB-T transmitter multiplexes a couple of TV channels into one program stream, comparable to the technology used in satellite TV broadcasting (DVB-S). The bandwidth of a program stream can reach from 5 to about 32 Mbit/s. The user of the service is required to have a Set Top Box (STB) or ITV which is able to receive, demultiplex and decode the selected channel.

DVB-T basically allows to broadcast video via the program stream and additionally enables the transfer of data, for example by the IP over DVB standard [13]. Several backchannels (e.g. GPRS, 3G, POTL) are enumerated in this standard.

To operate a DVB-T transmitter also requires a frequency license. The TV broadcasting in Austria has changed from analogue to digital transmission during the last year. Because of the topographic situation a certain amount of DVB-T stations especially in mountain and valley regions have to be installed to achieve an intended coverage. Usually these regions also lack of appropriate Internet broadband services. Currently the Austrian gov-

ernment supports providers in setting up these regional DVB-T broadcasting stations. This could be a chance to connect peripheral real estates with reasonable Internet services using DVB-T data transfer on downlink and WLAN IEEE 802.11, especially in the 5 GHz frequency band, as a license free and cheap backchannel (Fig. 5).

3. Central IT systems and inhouse cabling

This section will describe the function of a central IT system in a real estate. Further on the variety of connection possibilities to the units in a building will be analyzed and discussed.

3.1 Central IT systems

The core of the real estate consists of several parts. The main idea is to have a flexible interface to connect one or more of the above discussed Last Mile Access Technologies. This interface is connected to a basic system composed of an Internet firewall, a router and an Ethernet switch with a number of ports according to the number of users or individual units. Recent Ethernet switches are capable to select the layer 1 connection by the type of modules (copper or fiber) which are plugged into the switch ports. The chassis, backplane and switching unit of the switch always remains the same, the physical switch port type can be selected very flexible and according to the needs. Also the physical uplink port type to the specific service provider can be selected by inserting and using an appropriate module. The bandwidth of current uplink modules ranges up to 10 Gbit/s per wavelength and connection.

In general the total bandwidth can be increased by adding more switches and/or uplink ports which connects to the service provider, also by different methods.

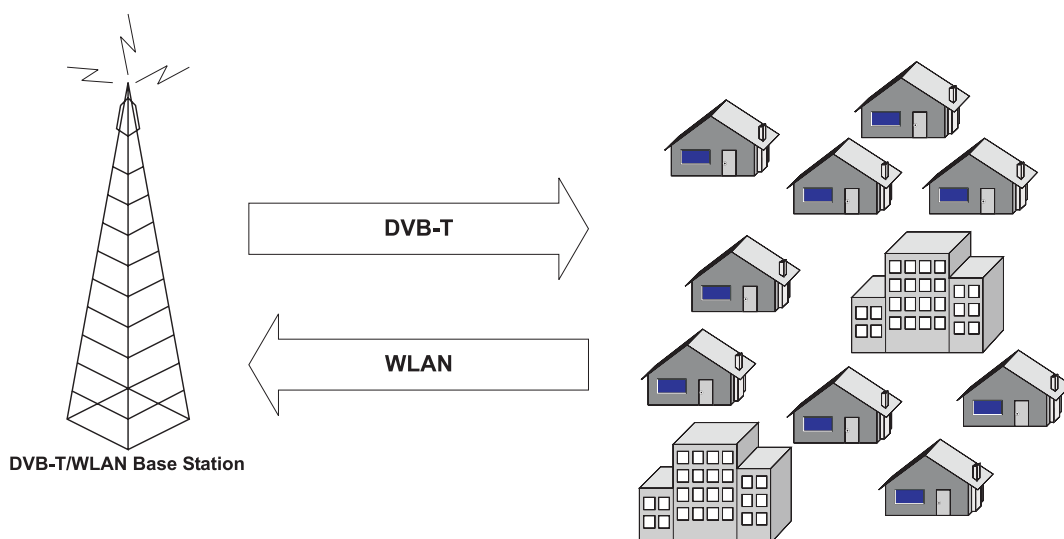

Fig. 5 DVB-T downlink and WLAN as a backchannel for Internet services

The real estates central IT system also should have capabilities for local network management, an uninterrupted power supply unit, local proxy servers for VoD services to keep the network traffic low and a local telephone system with a GSM or ISDN backup line for emergency calls during connection line failures. The listed equipment can easily be mounted in a single space saving 19" rack.

3.2. Inhouse cabling

There are a couple of methods to connect individual units to the central distribution point. We have to divide between elder buildings which already are equipped with existing cabling systems and novel buildings.

3.2.1 Existing real estates

One of the widespread cabling technologies to individual units in a real estate is coaxial cabling. Usually the intermediate frequency of a satellite LNB is distributed via these cables. By using the bus architecture of this cabling there is a technology existing to provide users with synchronous Internet services. Using this technology which is similar to coaxial Ethernet systems (e.g. Token Ring, 10Base2) used in the last decade, up to 100 Mbit/s synchronous can be supplied from a master device to a number of client devices in the units (ITU-T Rec. G.9954). The bandwidth for a single user simply can be planned and configured on the client device taking into account the sum of users connected to the master bus.

Using a Cable Modem Termination System (CMTS) similar to large Internet Service Providers in one or a group of real estates is an uneconomical technology. These systems in the leanest construction are designed to provide more than 5000 users. This concentration of users usually is not reached in a complex of buildings. A CMTS also shows another disadvantage, it is not able to supply synchronous data transfer. This feature is not intended by the DOCSIS (Data Over Cable Service Interface Specification, ITU-T Rec. J.112) standard for these systems, which disqualifies this system to be used in trend setting real estates.

One also has to take into account that replacing an existing cable system by another (e.g. CATx or fiber) is an expensive and dust creating task. Often owners of a real estate are not willing to authorize these reconstructions.

To have a future proof solution, an existing coaxial cabling should be replaced in case of high attenuation or an installation period of more than 20 years by either fiber or CATx cables. These two different cable types have to be selected regarding to the planned services, purpose or depending on the average connection length in a building.

3.2.2 New built real estates

In case of the construction of a novel real estate there is a variety of different methods for inhouse cabling which can be considered in the planning phase to connect units to the backbone:

3.2.2.1 Coaxial cable in combination with a CMTS or similar system

In most cases of existing buildings the coaxial cabling is not suitable for data transfer: High attenuation due to the age of the cable and the wrong cabling architecture because of its purpose to broadcast satellite TV signals make a coexistence with a CMTS impossible.

Even with a new cabling a cost value analysis with this architecture is negative due to the high investment cost of a CMTS and the low bandwidth performance.

3.2.2.2 Structured cabling standards CAT 5e, CAT 6, CAT 7

A very flexible solution is the use of the well known CAT standards (Cable and Telephone). These cables usually consist of shielded twisted copper pairs which are defined in several categories. For the multimedia inhouse cabling CAT 5e (TIA/EIA-568-B.2.2001), CAT 6a (ANSI/TIA/EIA-568-B.2-10), CAT 7 (ISO/IEC 11801:2002) be considered as reasonable candidates. CAT 5e can transport up to 1 Gbit/s with a cable length up to 100 m, while CAT 6a is able to transfer up to 10 Gbit/s (10Gbase-T) in the same range.

CAT 7 already is capable of transferring 10 Gbit/s. It also has currently been reported that this standard will be able to transfer 100 Gbit/s within a range of 100 m in 2013 [14].

3.2.2.3 Passive/active fiber cabling to the units

Taking the PON approach, every unit gets a single fiber, no more switching devices in the real estates central IT unit have to be installed. The switching is done by passive units instead of expensive and error prone fiber switches. This is the most economical and efficient way to connect a real estate to a service backbone. One single fiber from a central NOC is connected to a passive optical switch in the real estate which is connected to all units. By using different wavelengths (DWDM, WDM) to supply a complete unit or single end device the bandwidth can be raised easily for the future demands without changing expensive hardware components.

4. Conclusions

We have described the different access technologies and advantages in the previous sections. Tab. 2 gives an overview, which services can be used by a specific access technology.

RF based solutions do not have the optimal bandwidth performance for (HD) multicast IPTV or high quality video conferencing, but give a promising possibility to connect isolated settlement areas with broadband services. Especially DVBT services like IPTV and videoconferencing in either standard or high definition are expen-

Overview services per access technology

Tab. 2

Service/Technology	XDSL	FTTH	FSO	WIMAX	WLAN	DVBT with WLAN
House-, Security technologies	yes	yes	yes	yes	yes	yes
VoIP	yes	yes	yes	yes	yes	yes
Surveillance technologies	yes	yes	yes	yes	yes	yes
VoD	yes	yes	yes	yes	yes	yes
Basic Internet services	yes	yes	yes	yes	yes	yes
IPTV (multicast)	yes	yes	yes	no	no	no
Videoconferencing	yes	yes	yes	yes	yes	no
IPTV HD	no	yes	yes	no	no	no
Videoconferencing HD	no	yes	yes	no	no	no

FTTH with either active or passive PON has been shown the best future proof solution to connect real estates to capacious broadband Internet services. It is the current situation that fiber cables are not available to the buildings where it would be needed. For these reasons and also for the economic future of Europe there have to be done specific infrastructure investments by the European Union and/or local governments.

Connecting a real estate with FTTH usually creates construction costs. To reduce these costs the water connection which leads inside the building can be used. The pipe diameters range up to 2" depending on the number of users and the water throughput. It is an interesting approach to connect the building with fiber cables via these pipes. A certain amount of construction costs (digging and core drilling) can be saved [15].

The second best alternative to connect and interconnect real estates with the mentioned and more broadband services is a FSO system. To reduce line failures to a minimum an FSO ring architecture can be established between single buildings.

RF based solutions are an interesting approach for peripheral areas where the installation of fiber cables is an expensive venture, especially in rural areas with low population density. Unfortunately

sive methods in terms of hardware. In comparison to satellite transmissions DVBT provisioning is very much lower because of the given topological situations. Economically spoken, a satellite transponders coverage reaches much more users with higher bandwidth than a single DVBT transmitter. Even if the number of DVBT stations is formidable increased, a satellite transponder is cheaper and more effective.

The recommended future proof solution for inhouse cabling of a trend setting real estate delivering its users high quality and economic services is using either structured cabling (CAT standards, especially CAT 7 with up to 100 Gbit/s) or a single fiber connected to a supplying PON.

Comparing all above mentioned methods, a general recommendation and reliable economical estimation per method cannot be done at this time. Hence these solutions are mostly just test-beds which are not in a global rollout, the adequate solution has to be developed taking into account the specific economical aspects as the cases arise.

Acknowledgements

The authors wish to acknowledge the assistance and support of GM1.TV and Cisco Systems.

References

[1] <http://www.gm1.tv>
 [2] <http://www.itu.int/publications/default.aspx>
 [3] LEITGEB, E., GEBHART, M., FASSER, P.: *Reliability of Free Space Laser Communications - Investigations at the TU Graz*, 8th WCA Technical Symposium, 2002, CDROM
 [4] LEITGEB E., BREGENZER, J., FASSER, P., GEBHART, M.: *Free Space Optics - Extension to Fiber- Networks for the "Last Mile"*, Laser and Electro-Optics Society, 2002, 15th annual meeting of IEEE, vol. 2, p. 459-460
 [5] LEITGEB, E., BREGENZER, J., GEBHART, M., FASSER, P., MERDONIG, A.: *Free Space Optics - Broadband Wireless Supplement to Fiber-Networks*, LASE, 2003, vol. 4975, p. 57-68

- [6] LEITGEB, E., GEBHART, M., BIRNBACHER, U., SHEIKH MUHAMMAD, S., CHLESTIL, CH.: *Applications of Free Space Optics for Broadband Access*, OPNETEC, 2004, p 579-586
- [7] IEC/EN 60825-12: 'Safety of laser products - Part 12: Safety of free space optical communication systems used for transmission of information'
- [8] LEITGEB, E., GEBHART, M., BIRNBACHER, U., SCHROTTER, P., MERDONIG, A., TRUPPE A.: *Hybrid Wireless Networks for Civil-Military-Cooperation (CIMIC) and Disaster Management*, SPIE, 2004, vol. 5614, p. 140-145
- [9] LEITGEB, E., GEBHART, M., BIRNBACHER, U.: *Optical networks, last mile access and applications*, Journal of Optical and Fiber Communication Reports, 2005, Rep 2, p. 56-85
- [10] SAUNDERS, S. R., ARAGON-ZAVALA, A.: *Antennas and Propagation for Wireless Communication Systems*, Second Edition, John Wiley & Sons, 2007
- [11] MANDL, P., CHLESTIL, CH., ZETTL, K., LEITGEB, E.: *Hybrid systems using Optical Wireless, Fiber Optics and WLAN for temporary multimedia applications*, 9th International Conference on Telecommunication, ConTel 2007, p. 73-76
- [12] EPPLE, B., HENNINGER, H.: *Discussion on Design Aspects for free-Space Optical Communication Terminals*, IEEE Communications Magazine, October 2007, p. 62-68
- [13] EN301192: *Specifications for Data Broadcasting*, European Telecommunications Standards Institute (ETSI), 2004
- [14] HODGIN, R.: *Cat-7 copper theorized to transmit 100 Gbit/s in exec of 100 meters using future modem*, TG Daily
- [15] DIN IEC 60794-3-60: *Optical fibre cables - Part 3-60: Outdoor optical fibre cables - Family specification for drinking water pipe cables and sub-ducts for installation by blowing and/or pulling/dragging in/floating into drinking water pipes (IEC 86A/1140/CD:2007)*.

COMMUNICATIONS – Scientific Letters of the University of Zilina Writer's Guidelines

1. Submissions for publication must be unpublished and not be a multiple submission.
2. Manuscripts written in **English language** must include **abstract** also written in English. The submission should not exceed **10 pages** with figures and tables (format A4, Times Roman size 12). The **abstract** should not exceed 10 lines.
3. Submissions should be sent: **by e-mail** (as attachment in application MS WORD) to one of the following addresses: *komunikacie@uniza.sk* or *holesa@nic.uniza.sk* or *vrablova@nic.uniza.sk* or *polednak@fsi.uniza.sk* **with a hard copy** (to be assessed by the editorial board) **or on a CD** with a hard copy to the following address: Zilinska univerzita, OVaV, Univerzitná 1, SK-010 26 Zilina, Slovakia.
4. Abbreviations, which are not common, must be used in full when mentioned for the first time.
5. Figures, graphs and diagrams, if not processed by Microsoft WORD, must be sent in electronic form (as GIF, JPG, TIFF, BMP files) or drawn in contrast on white paper, one copy enclosed. Photographs for publication must be either contrastive or on a slide.
6. References are to be marked either in the text or as footnotes numbered respectively. Numbers must be in square brackets. The list of references should follow the paper (according to **ISO 690**).
7. The author's exact **mailing address of the organisation where the author works, full names, e-mail address or fax or telephone number**, must be enclosed.
8. The editorial board will assess the submission in its following session. In the case that the article is accepted for future volumes, the board submits the manuscript to the editors for review and language correction. After reviewing and incorporating the editor's remarks, the final draft (before printing) will be sent to authors for final review and adjustment.
9. The deadlines for submissions are as follows: September 30, December 31, March 31 and June 30.

COMMUNICATIONS

SCIENTIFIC LETTERS OF THE UNIVERSITY OF ZILINA
VOLUME 10**Editor-in-chief:**

Prof. Ing. Pavel Polednak, PhD.

Editorial board:

Prof. Ing. Jan Bujnak, CSc. – SK
 Prof. Ing. Otakar Bokuvka, CSc. – SK
 Prof. RNDr. Peter Bury, CSc. – SK
 Prof. RNDr. Jan Cerny, DrSc. – CZ
 Prof. Eduard I. Danilenko, DrSc. – UKR
 Prof. Ing. Branislav Dobrucky, CSc. – SK
 Prof. Dr. Stephen Dodds – UK
 Dr. Robert E. Caves – UK
 Dr.hab Inž. Stefania Grzeszczyk, prof. PO – PL
 Doc. PhDr. Anna Hlavnova, CSc. – SK
 Prof. Ing. Vladimír Hlavna, PhD. – SK
 Prof. RNDr. Jaroslav Janacek, CSc. – SK
 Prof. Ing. Hermann Knoflacher – A
 Dr. Ing. Helmut König, Dr.h.c. – CH
 Prof. Ing. Milan Moravcik, CSc. – SK
 Prof. Ing. Gianni Nicoletto – I
 Prof. Ing. Ludovít Parilak, CSc. – SK
 Ing. Miroslav Pfliegel, CSc. – SK
 Prof. Ing. Pavel Polednak, PhD. – SK
 Prof. Bruno Salgues – F
 Prof. Andreas Steimel – D
 Prof. Ing. Miroslav Steiner, DrSc. – CZ
 Prof. Ing. Pavel Surovec, CSc. – SK
 Prof. Josu Takala – SU
 PhDr. Radoslava Turska, CSc. – SK
 Doc. Ing. Martin Vaculik, CSc. – SK

Address of the editorial office:

Zilinská univerzita
 Office for Science and Research
 (OVaV)
 Univerzitná 1
 SK 010 26 Zilina
 Slovakia
 E-mail: komunikacie@nic.uniza.sk,
 polednak@fsi.uniza.sk

Each paper was reviewed by two reviewers.

Journal is excerpted in Compendex

It is published by the University of Zilina in
 EDIS - Publishing Institution of Zilina University
 Registered No: 1989/98
 ISSN 1335-4205

Published quarterly

Single issues of the journal can be found on:
<http://www.utc.sk/komunikacie>